



# LC10 Series AC Servo Drive

---

## User's Manual



Shenzhen Xinlichuan Electric Co., Ltd.

---

# Contents

<b>Chapter I Safety Precautions</b> .....	<b>1</b>
<b>Chapter II Electrical Specifications</b> .....	<b>1</b>
2.1 Specifications .....	1
2.2 Drive model .....	2
<b>Chapter III Installation</b> .....	<b>3</b>
3.1 Installation of servo drive unit .....	3
3.1.1 Installation environment .....	3
3.1.2 Installation method .....	3
3.1.3 Installation dimensions .....	4
3.2 Servo motor installation .....	4
3.2.1 Installation environment .....	4
3.2.2 Installation method .....	4
<b>Chapter IV Wiring</b> .....	<b>5</b>
4.1 Terminal description .....	5
4.2 Main circuit wiring .....	6
4.2.1 Definition of main circuit terminals .....	6
4.2.2 How to use the main circuit power terminal (spring type) .....	6
4.2.3 Drive wiring diagram .....	7
4.3 Definition of wiring terminal .....	8
4.3.1 Definition of communication terminals (CN1/CN2) .....	8
4.3.2 Definition of control terminals (CN1) .....	8
4.3.3 Encoder terminal definition (CN2) .....	9
4.4 Control signal terminal wiring .....	11
4.4.1 DI input circuit .....	11
4.4.2 High-speed pulse input circuit .....	11
4.4.3 DO output circuit .....	13
4.4.4 Analog input circuit .....	13
4.4.5 Pulse feedback output circuit .....	13
<b>Chapter V Panel Display and Operation</b> .....	<b>14</b>
5.1 Panel introduction and description .....	14
5.1.1 Description of panel keys .....	14
5.1.2 How to operate keys on the panel .....	14
5.1.3 Status display .....	14
5.1.4 Display of parameter number .....	15
5.1.5 Parameter value display .....	15
5.1.6 Monitor parameter display (POB set parameters) .....	15
5.2 Common operations .....	17
5.2.1 JOG mode operation .....	17
5.2.2 Internal power-up enable .....	17
5.2.3 Initialization parameters .....	17
5.2.4 Manual reset alarm .....	17
<b>Chapter VI Control Mode Description</b> .....	<b>18</b>
6.1 Location mode description .....	18
6.1.1 Position mode wiring diagram .....	18

---

6.1.2	Parameters related to external pulse control .....	19
6.1.3	Parameters related to internal multi-segment position control .....	19
<b>6.2</b>	<b>Speed mode description .....</b>	<b>21</b>
6.2.1	Speed mode wiring diagram .....	21
6.2.2	Functions related to external speed mode .....	22
6.2.3	Internal multi-speed related functions .....	23
<b>6.3</b>	<b>Torque mode description .....</b>	<b>24</b>
6.3.1	Torque mode wiring diagram .....	24
6.3.2	Functions related to external torque mode .....	25
<b>6.4</b>	<b>Detailed description of DI/DO port function configuration .....</b>	<b>27</b>
6.4.1	DI function description .....	27
6.4.2	DO function description .....	30
<b>Chapter VII</b>	<b>Parameter Description .....</b>	<b>32</b>
7.1	P01 set drive parameters .....	32
7.2	P02 set basic control parameters .....	32
7.3	P03 set terminal input parameters .....	33
7.4	P04 set terminal output parameters .....	34
7.5	P05 set position control parameters .....	34
7.6	P06 set speed control parameters .....	37
7.7	P07 set torque control parameters .....	38
7.8	P08 set gain parameters .....	39
7.9	P09 set self-tuning parameters .....	40
7.10	P0A set fault and protection parameters .....	40
7.11	P0B set monitoring parameters .....	41
7.12	P0C set communication parameters .....	42
7.13	P0D set auxiliary function parameters .....	43
7.14	P11 set multi-segment position function parameters .....	44
7.15	P12 set multi-segment speed parameters .....	46
7.16	P17 set virtual DIDO parameters .....	48
7.17	P30 set communication reading servo related variables .....	50
7.18	P31 set communication given servo related variables .....	51
<b>Chapter VIII</b>	<b>Troubleshooting .....</b>	<b>51</b>
8.1	Fault and Warning Code List .....	51
8.1.1	Fault code table (to reset the fault, you need to cancel the enable first) .....	51
8.1.2	Warning code table (warnings can be reset directly, no need to disable) .....	54
<b>Chapter IX</b>	<b>MODBUS Communication .....</b>	<b>55</b>
9.1	Wiring and Setup .....	55
9.1.1	Topology structure .....	55
9.1.2	Related parameters .....	55
9.1.3	Communication address description .....	56
9.2	MODBUS communication protocol .....	56
9.2.1	Read register command (0x06) .....	56
9.2.2	Write single-register command (0x06) .....	57
9.2.3	Write multi-register command (0x10) .....	58
9.2.4	Response exception and error codes .....	59
9.2.5	CRC check .....	59

## Chapter I Safety Precautions

Before using the servo drive system, please read the related precautions carefully, and be sure to abide by the safety precautions and operating procedures for installation and commissioning. The company is not responsible for any equipment damage or personal injury caused by not operating in accordance with the requirements.

- ◆ This product is a general industrial product and is not intended for use in machines and systems that are related to human life.
- ◆ Only qualified personnel are allowed to perform wiring, running, maintenance, inspection and other operations.
- ◆ Safety devices must be equipped if it is used on devices that may cause serious accidents or losses.
- ◆ Although this product is perfectly sound in terms of quality control, the noise, static electricity, input power supply, wiring, parts and other factors may cause unexpected actions. Please fully consider mechanical safety measures to ensure safety within the possible range of motion

## Chapter II Electrical Specifications

### 2.1 Specifications

Input power	Single-phase 220VAC	
Working environment	Temperature	0~45℃
	Humidity	≤90%RH, no condensation
	Elevation	Altitude ≤1000m
	Installation environment	No corrosive gas, flammable gas, oil mist or dust.
	Installation mode	Vertical
Encoder	Support 17-bit incremental/absolute value encoder, 23-bit incremental/absolute value encoder	
Output power	24V voltage output	100mA, supply power to DI port and pulse port.
Control signal	Digital input	8-channel common digital input, function can be configured.
	Digital output	6-channel digital output, function can be configured.
Pulse signal	Input	2-channel high-speed input: support up to 1MHz pulse, duty cycle 50%. Support pulse input mode: PULS+DIR, A+B, CW+CCW
	Output	3-channel high-speed pulse output, output signal form: 5V differential signal. 1 channel Z signal single-ended output signal.
Analog signal	Input	2-channel analog input, 12-bit resolution, input range -9.5 ~ +9.5V. Among them, AI2 is fixed as the torque limit input.
	Output	None
Communication function	RS485 communication, ModbusRTU protocol.	
Display panel and key operation	5 keys (Mode, Set, Left, Up, Down) and 6 nixie tubes	
Braking resistor	Built-in 50W 40Ω braking resistor. For frequent braking occasions, an external braking resistor is required.	

## 2.2 Drive model

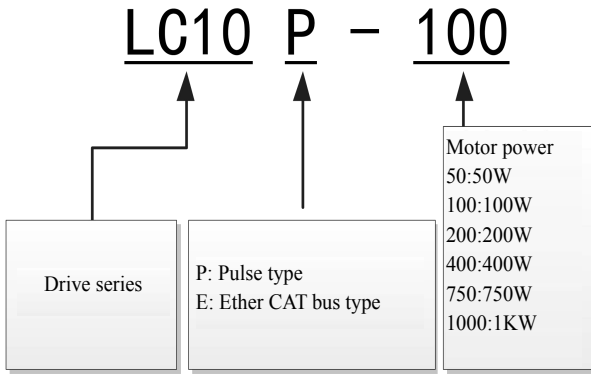

## 2.3 Motor model

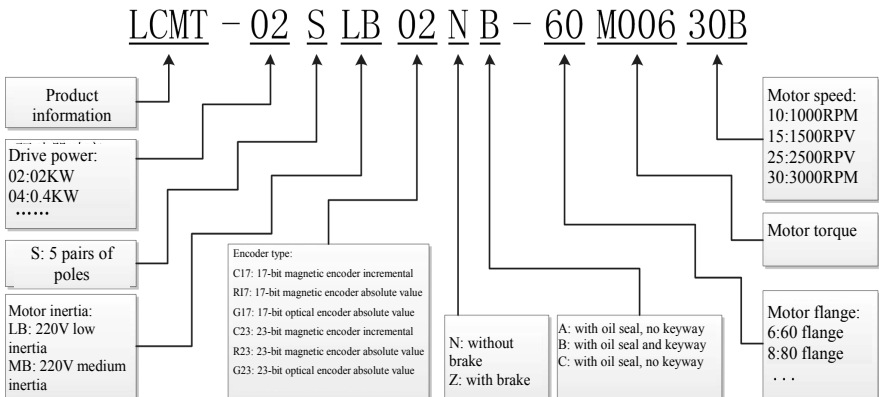

## Chapter III Installation



### Warning

- The storage and installation of the product must meet the environmental conditions.
- Damaged or incomplete products should not be installed and used.
- The product requires fireproof materials for installation, and must not be installed on or near flammable materials to prevent fire.
- The servo drive unit must be installed in the electric cabinet to prevent the intrusion of dust, corrosive gas, conductive objects, liquids, and inflammables.
- Servo drive unit and servo motor should be protected from vibration and shock.
- It is strictly forbidden to drag the servo motor wires and encoder lines.

### 3.1 Installation of servo drive unit



### Note

- The servo drive unit must be installed in a well-protected electric cabinet.
- The servo drive unit must be installed in the specified direction and interval, and ensure good heat dissipation conditions.
- Do not install on or near flammable objects to prevent fire.

#### 3.1.1 Installation environment

- ◆ Operating temperature/humidity: 0~55°C (no frost), < 90%RH (no condensation).
- ◆ Storage temperature/humidity: -20~65°C (no frost), < 90%RH (no condensation).
- ◆ Atmospheric environment: inside the control cabinet, without corrosive or flammable gas, oil mist, dust, etc.
- ◆ Elevation: below 1000m above sea level.
- ◆ Vibration: < 0.5G (4.9m/s<sup>2</sup>), 10~60 Hz (non-continuous operation).
- ◆ Protection: The servo drive itself has no protection, so it must be installed in a well-protected electrical cabinet, and protected from the intrusion of corrosive or flammable gases, conductive objects, metal dust, oil mist and liquids.

#### 3.1.2 Installation method

- ◆ The servo drive of our company is in vertical structure, so please install it vertically. The installation direction should be upwards perpendicular to the installation surface.
- ◆ The installation layout of single or multiple servo drives is shown in the figure below.

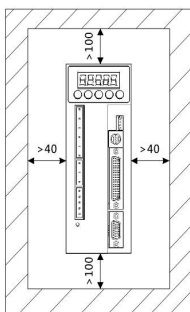

Installation interval of a single servo drive unit

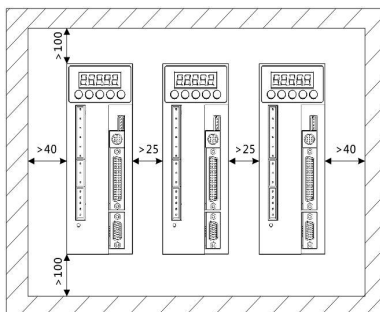

Installation interval of multiple servo drives

### 3.1.3 Installation dimensions

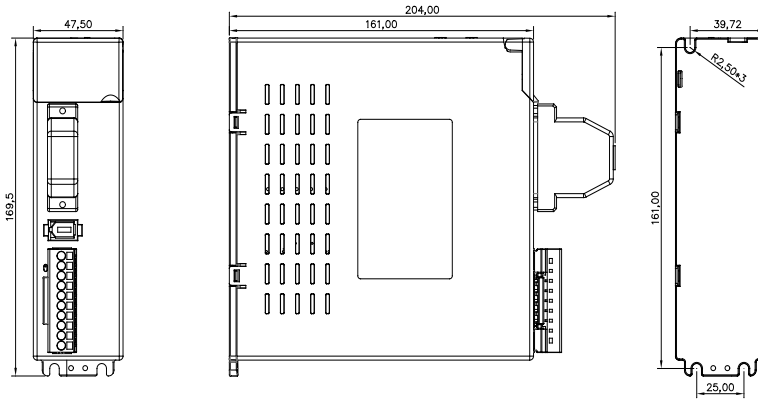

## 3.2 Servo motor installation



Warning

- It is strictly forbidden to knock the shaft end of the motor, or the motor encoder may be damaged.

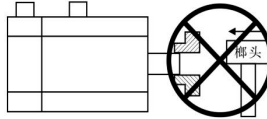

### 3.2.1 Installation environment

- ◆ Operating temperature/humidity: 5~40°C (no frost), < 90%RH (no condensation).
- ◆ Storage temperature/humidity: -20~55°C (no frost), < 80%RH (no condensation).
- ◆ Atmospheric environment: indoor (no exposure), without corrosive or flammable gas, oil mist, dust, etc.
- ◆ Elevation: below 1000m above sea level.
- ◆ Vibration: < 0.5G (4.9m/s<sup>2</sup>), 10~60 Hz (non-continuous operation).
- ◆ Protection level: IP54

### 3.2.2 Installation method

- ◆ Installation direction: To prevent water, oil and other liquids from flowing into the motor from the motor outlet, please place the cable outlet at the bottom. If the motor shaft is installed upwards and a reducer is attached, it is necessary to prevent oil stains in the reducer from penetrating into the motor from the motor shaft.
- ◆ Concentric: When connecting with the machine, please use the coupling, and keep the axle center of the servo motor and the axle center of the machine in a straight line.
- ◆ Cable: Do not "bend" or put "tension" on the cables, do not over-tension the cable when wiring (using).
- ◆ Fixing: The motor installation must be firm, and there should be anti-loosening measures.

## Chapter IV Wiring



Warning

- The power supply of this series of drives is single-phase 220V. The power supply must be identified when wiring.
- When using this product, the user must consider safety protection measures in the design and assembly to prevent accidents caused by wrong operations.
- The drive terminals U, V and W must correspond to the motor U, V and W, or it may cause a crash.
- The drive and motor must be well grounded.
- The power must be turned off at least 5 minutes before disassembling the drive.
- It is forbidden to turn on/off the power frequently. When the power is off, you need to wait for the nixie tube to go out before powering on again.
- When using the internal braking resistor, the short-circuit wire must be connected between terminals B2 and B3. It is forbidden to connect the wire between B1 and B2 directly.

### 4.1 Terminal description

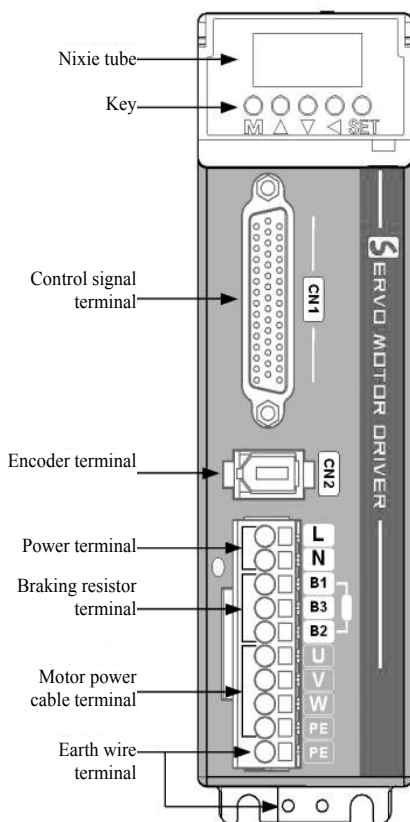



## 4.2 Main circuit wiring

### 4.2.1 Definition of main circuit terminals

#### ◆ Input power terminal

No.	Signal definition	Functions
1	L	Power terminal, can be connected to AC single-phase 220V
2	N	

#### ◆ Braking resistor terminal

Pin	Signal definition	Functions	Description
1	B1	DC bus positive terminal output DCP	The positive terminal of the built-in resistor is connected to B1. When using the built-in resistor, please short-circuit B2 and B3. When using external resistor, please connect the resistor between B1 and B2 (B2 and B3 must be disconnected).
2	B3	Built-in braking resistor negative output.	
3	B2	Brake transistor collector output	

#### ◆ Motor terminal

Socket No.	Signal definition	Functions
1	U	Connect to motor phase U
2	V	Connect to motor phase V
3	W	Connect to motor phase W
4	PE	Connect to motor housing

### 4.2.2 How to use the main circuit power terminal (spring type)

- Strip the outer sheath of the wire to expose 8-9mm bare copper wire.
- The pressing method is as follows:
  - Use the control bar provided with the servo drive to pry up the slot (as shown in Fig. A);
  - Insert a slotted screwdriver into the terminal opening (3.0~3.5mm width at the end), then press firmly to open the slot (as shown in Fig. B).
- The pressing method is as follows:

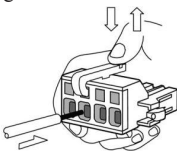

Fig. A

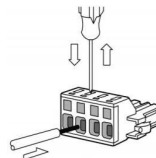
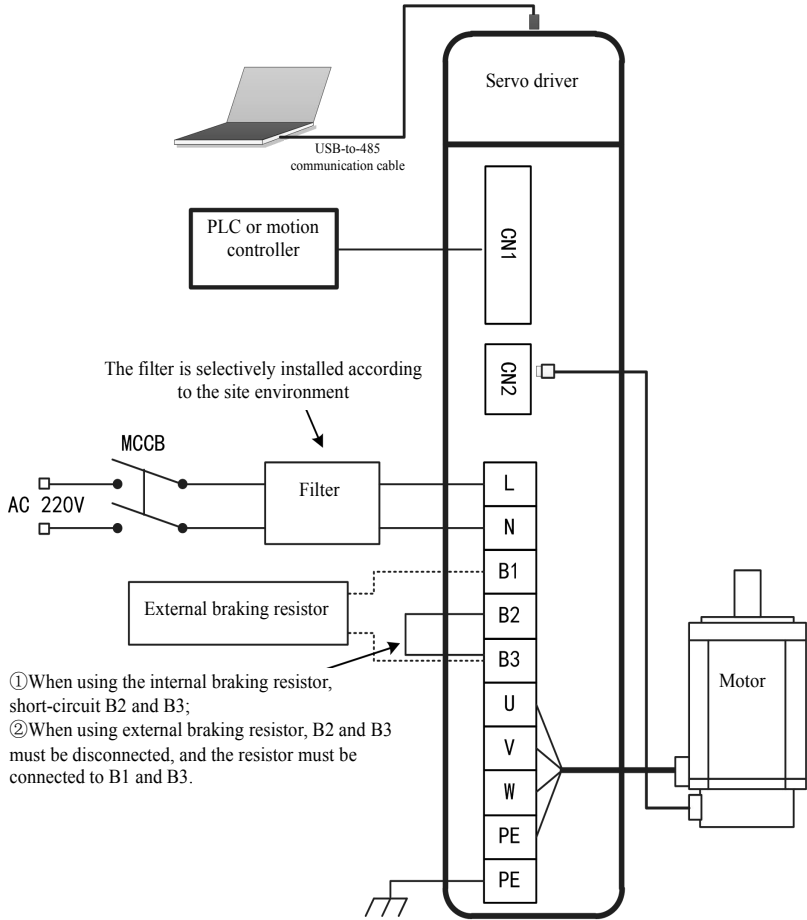

Fig. B

### 4.2.3 Drive wiring diagram



Note: When using the internal braking resistor, short-circuit B2 and B3 (connected at the factory); when using the external braking resistor, disconnect B2 and B3, and connect the external braking resistor between B1 and B2.

## 4.3 Definition of wiring terminal

### 4.3.1 Definition of communication terminals (CN1/CN2)

Pin	Network cable color	Signal definition
1	White/orange	NC
2	Orange	NC
3	White/green	NC
4	Blue	485+
5	White/blue	485-
6	Green	NC
7	White/brown	NC
8	Brown	GND

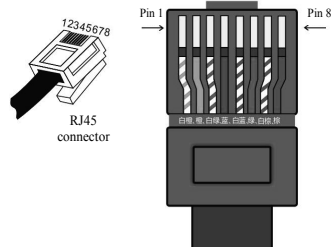

Registered jack pin order

### 4.3.2 Definition of control terminals (CN1)

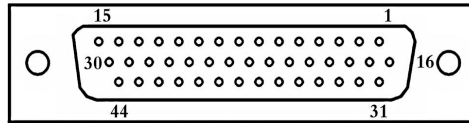

Terminal welding surface

Pin	Signal name	Function name	Notes or supplementary instructions
42	PUL+	Pulse input PUL negative terminal, 5V interface.	When the 5V pulse interface is connected to 12V or 24V pulse, an external resistor needs to be connected in series; When using the 24V pulse input common terminal OPC, the 24V pulse signal can be directly connected. At this moment, PUL+ and DIR+ are not connected. Up to 1MHz frequency is supported.
41	PUL-	Pulse input PUL positive terminal, 5V interface.	
40	DIR+	Pulse direction DIR negative terminal, 5V interface.	
39	DIR-	Pulse direction DIR positive terminal, 5V interface.	
38	OPC	24V pulse input common terminal	For detailed description of parameter configuration, please refer to chapter 6.4.1.
3	DI1	Digital input 1	
4	DI2	Digital input 2	
5	DI3	Digital input 3	
6	DI4	Digital input 4	
18	DI5	Digital input 5	
19	DI6	Digital input 6	
20	DI7	Digital input 7	
21	DI8	Digital input 8	
10	DICOM	DI port common terminal	DICOM can be connected to +24V or 0V
44	+24VO	24V power output positive terminal	The maximum output current of 24V is 100mA, which can only be used as power supply for the DI port. <b>It is forbidden to drive external loads.</b>
11	COM-	24V power output negative terminal	
12	COM-		

8	DO1A	Terminal A of digital output 1	For detailed description of parameter configuration, please refer to chapter 6.4.2.
7	DO1B	Terminal B of digital output 1	
6	DO2A	Terminal A of digital output 2	
5	DO2B	Terminal B of digital output 2	
4	DO3A	Terminal A of digital output 3	
3	DO3B	Terminal B of digital output 3	
2	DO4A	Terminal A of digital output 4	
1	DO4B	Terminal B of digital output 4	
25	DO5A	Terminal A of digital output 5	
9	DO5B	Terminal B of digital output 5	
27	DO6A	Terminal A of digital output 6	
26	DO6B	Terminal B of digital output 6	
28	OA+	Encoder frequency division output A+	P05-17: The number of encoder frequency division pulses, used to set the number of pulses output by the drive for each rotation of the motor.
13	OA-	Encoder frequency division output A-	
29	OB+	Encoder frequency division output B+	
14	OB-	Encoder frequency division output B-	
30	OZ+	Encoder frequency division output Z+	
15	OZ-	Encoder frequency division output Z-	
20	GND	Digital signal ground	
37	CZ+	Z signal collector output +	This pin is not currently available
36	CZ-	Z signal collector output -	
16	AGND	Analog input AGND	All can be used for speed or torque command input, which can be selected by parameter setting of P6 and P7
17	AI2	Analog input AI2	
18	AGND	Analog input AGND	
19	AI1	Analog input AI1	

### 4.3.3 Encoder terminal definition (CN2)

◆ Schematic diagram of drive encoder terminals

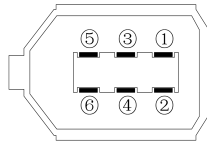

Encoder terminal pin diagram

◆ Drive encoder pin definition

Servo side	Name	Wire color	
1	VCC	Encoder power supply +5V	Red
2	GND	Encoder power ground	Yellow
3	/	/	/
4	/	/	/
5	SD+	Encoder signal+	Blue
6	SD-	Encoder signal-	Black

◆ Schematic diagram of motor terminals

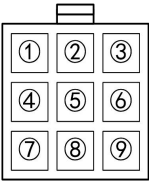

9-pin Amp plug male

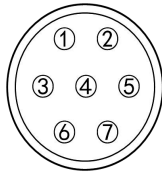

7-pin aviation plug

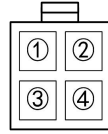

4-pin Amp plug

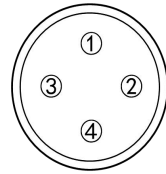

4-pin aviation plug

◆ Motor encoder terminal pin definition (Amp plug is the same as the aviation plug)

Motor side		Name	Wire color
1	PE	Shielded cable	
2	E-	Battery power supply negative	White
3	E+	Battery power supply positive	Green
4	SD-	Encoder signal-	Black
5	GND	Encoder power ground	Yellow
6	SD+	Encoder signal+	Blue
7	VCC	Encoder power supply +5V	Red

◆ Motor power line pin definition

Motor side (Amp plug)		Name	Wire color
1	U	Motor phase U	Brown
2	V	Motor phase V	Blue
3	W	Motor phase W	Yellow
4	PE	Motor housing	Green

Motor side (aviation plug)		Name	Wire color
1	PE	Motor housing	Yellow/green
2	U	Motor phase U	Black
3	V	Motor phase V	Grey
4	W	Motor phase W	Brown

## 4.4 Control signal terminal wiring

### 4.4.1 DI input circuit

- ◆ NPN type input wiring

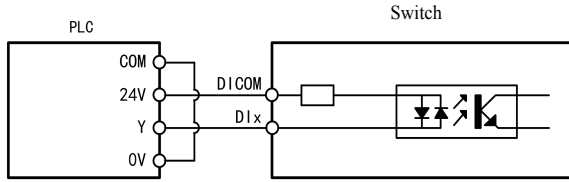

- ◆ PNP type input wiring

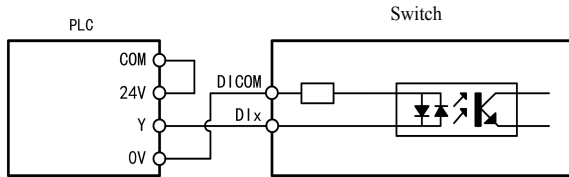

- ◆ Switch input wiring

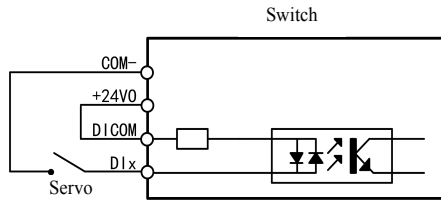

### 4.4.2 High-speed pulse input circuit

- ◆ 5V differential pulse input wiring

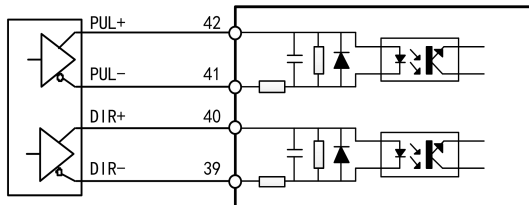

◆ 24V NPN pulse wiring (built-in resistor)

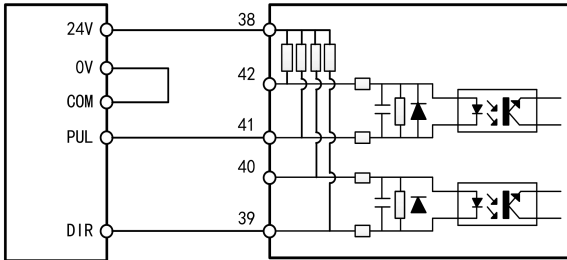

◆ 24V PNP pulse wiring (built-in resistor)

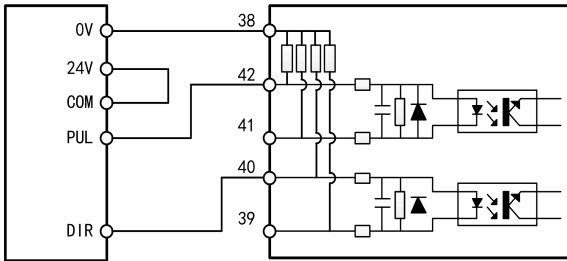

◆ NPN pulse wiring (external resistor)

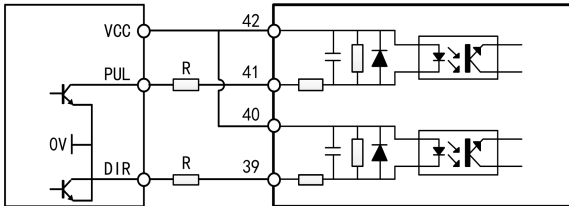

◆ PNP pulse wiring (external resistor)

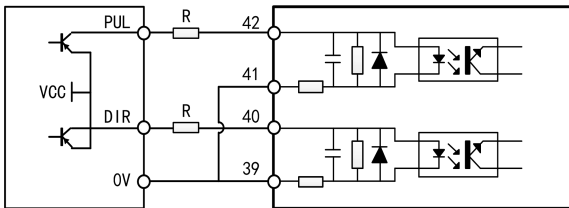

**Note:** With external resistor wiring, when signal voltage  $VCC=24V$ ,  $R=1.5K\Omega$ ; when signal voltage  $VCC=12V$ ,  $R=1K\Omega$ ;  
When signal voltage  $VCC=5V$ ,  $R=0\Omega$ .

### 4.4.3 DO output circuit

- ◆ DO output wiring (connect to optocoupler)

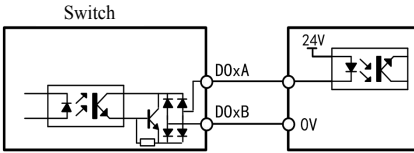

Low level output wiring

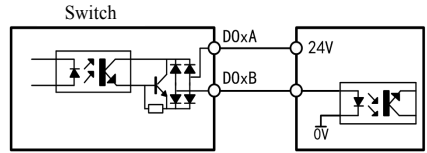

High level output wiring

- ◆ DO output wiring (connect to relay)

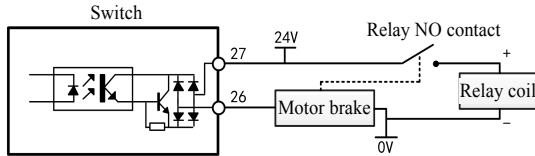

The brake output signal controls the motor brake through the relay

### 4.4.4 Analog input circuit

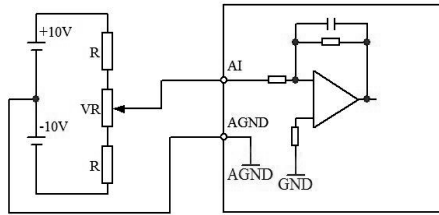

### 4.4.5 Pulse feedback output circuit

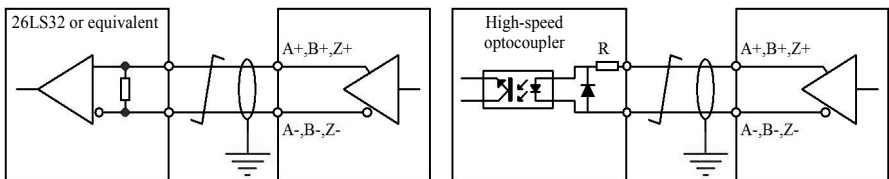



## Chapter V Panel Display and Operation

### 5.1 Panel introduction and description

#### 5.1.1 Description of panel keys

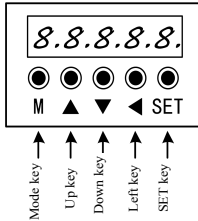

Name	General function
M	Switch between modes, return to the previous menu
▲	Increase the value of the blinking digit of the LED nixie tube
▼	Decrease the value of the blinking digit of the LED nixie tube
◀	Change the blinking position of the LED nixie tube View the high-order value of data longer than 5 digits
SET	Go to next level menu Execute commands such as storing parameter values

#### 5.1.2 How to operate keys on the panel

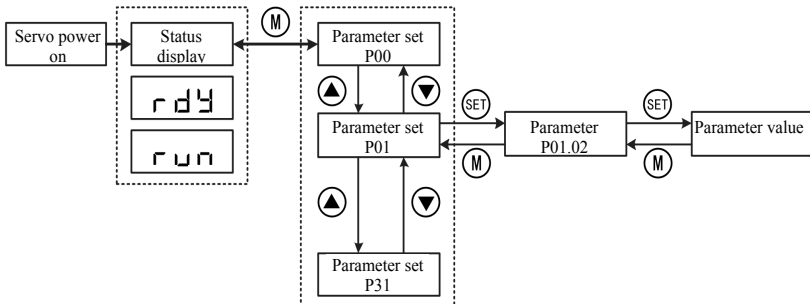

#### 5.1.3 Status display

Display	Name	Occasion	Meaning
RESET	Reset Servo initializes	The moment the servo is powered on.	The drive is in initialization or reset state. When the initialization or reset completes, switch to other states automatically.
nr d	Nrd Servo not ready	Servo initialization is complete, but the drive is not ready.	The servo is inoperable because the main circuit is not powered on.

rdy	Rdy Servo ready	The drive is ready.	The servo drive is in operable state, waiting for the servo enable signal from the host computer.
run	Run Servo is running	The servo enable signal is active. (S-ON is ON)	The servo drive is running.
jog	Jog Jog running	The servo drive is in the jog running state.	Jog operation settings can be made.

### 5.1.4 Display of parameter number

The servo parameter number of this series consists of two parts: the parameter set and the number in the parameter set, as shown in the figure below:

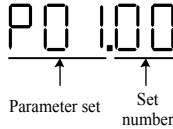

### 5.1.5 Parameter value display

- **Signed number with no more than 4 digits or unsigned numbers with no more than 5 digits**

Displayed on a single page (5-digit nixie tube); for signed numbers, the highest digit of the data "-" represents a negative sign.

Example: -9999 is displayed as follows:



Example: 65535 is displayed as follows:

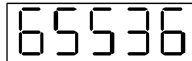

- **Signed numbers with more than 4 digits or unsigned numbers with more than 5 digits**

Displayed in pages from low to high digits, and every 5 digits is a page. Display method: current page + current page value, as shown in the figure below, press and hold the "◀" key for more than 2 seconds to switch the current page.

Example: -268435456 is displayed as follows:

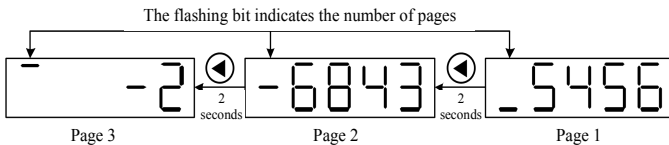

### 5.1.6 Monitor parameter display (P0B set parameters)

Functional code	Name	Unit	Meaning
P0B-00	Actual motor speed	rpm	The actual running speed of the servo motor, which is rounded to the nearest 1rpm
P0B-01	Speed command	rpm	The current speed command of the drive
P0B-02	Internal torque command	0.1%	The percentage of the actual output torque of the servo motor to the rated torque of the motor
P0B-03	DI signal monitoring	-	Corresponding level status of the 9 DI terminals: the upper half of the nixie tube lights up to indicate a high level; the lower half lights up to indicate a low level
P0B-05	DO signal monitoring	-	Corresponding level status of the 6 DO terminals: the upper half of the nixie tube lights up to indicate a high level; the lower half lights up to indicate a low level

P0B-07	Absolute position counter (32-bit decimal display)	Command unit	Current absolute position of the motor (command unit)
P0B-09	Mechanical angle (number of pulses from the home)	p	Current mechanical angle of the motor 0 corresponds to the mechanical angle of 0° P0B-09 maximum value: 65535 Actual mechanical angle = $\frac{P0B-09}{65536} \times 360.0^\circ$
P0B-10	Rotation angle	°	Current electrical angle of the motor
P0B-11	Corresponding speed information of input position command	rpm	Corresponding speed value of the position command of a single control cycle of the drive
P0B-12	Average load ratio	0.1%	The percentage of average load torque to motor rated torque
P0B-13	Input position command count	Command unit	Display the number of input position commands
P0B-15	Encoder position deviation value	p	Encoder position deviation = total number of input position commands - total number of encoder feedback pulses
P0B-17	Feedback pulse counter	p	Count and display the number of pulses fed back by the servo motor encoder (encoder unit)
P0B-19	Total power-on time	0.1s	Count and display the power-on time of the servo drive
P0B-21	A11 sampling voltage value	0.01V	Voltage value input by analog channel 1
P0B-22	A12 sampling voltage value	0.01V	Voltage value input by analog channel 2
P0B-24	Phase current rms value	0.01A	Servo motor phase current rms value
P0B-26	Bus voltage value	0.1V	The DC bus voltage value of the main circuit, that is, the voltage between the drive P⊕, -
P0B-27	Module temperature value	°C	Servo drive internal power module temperature
P0B-33	Fault recording	-	Set the number of times to view historical faults 0 - current fault 1- Last fault 2- Last two faults ..... 9- Last 9 faults
P0B-34	Fault code of selected time	-	P0B-33 selected fault code When there is no fault, the displayed value of P0B-34 is "Er.000"
P0B-35	Selected fault timestamp	s	P0B-34 shows the total servo running time when the fault occurs When there is no fault, the displayed value of P0B-35 is "0"
P0B-37	Motor speed at selected fault	rpm	The servo motor speed when the fault displayed by P0B-34 occurs When there is no fault, the displayed value of P0B-37 is "0"
P0B-38	Motor U-phase current at the selected fault	0.01A	The rms value of the U-phase winding current of the servo motor when the fault displayed by P0B-34 occurs When there is no fault, the displayed value of P0B-38 is "0"
P0B-39	Motor V-phase current at the selected fault	0.01A	The rms value of the V-phase winding current of the servo motor when the fault displayed by P0B-34 occurs When there is no fault, the displayed value of P0B-39 is "0"
P0B-40	Bus voltage at selected fault	V	The DC bus voltage value of the main circuit when the fault displayed by P0B-34 occurs When there is no fault, the displayed value of P0B-40 is "0"
P0B-41	Input terminal status at selected fault	-	The corresponding high and low level status of 9 DI terminals when the fault displayed by P0B-34 occurs Viewing method is the same as P0B-03 When no fault occurs, P0B-41 shows that all DI terminals are low level, and the corresponding decimal value is "0"
P0B-42	Output terminal status at selected fault	-	The corresponding high and low level status of 5 DO terminals when the fault displayed by P0B-34 occurs Viewing method is the same as P0B-05 When no fault occurs, P0B-42 shows that all DO terminals are low level, and the corresponding decimal value is "0"
P0B-53	Position deviation counter (32-bit decimal display)	Command unit	Position deviation = total number of input position commands - total number of encoder feedback pulses Note: The position deviation (command unit) is the value converted from the encoder position deviation. When doing division, there is a loss of precision.

P0B-55	Actual motor speed	0.1rpm	The actual running speed of the servo motor, accurate to 0.1rpm
P0B-64	Real-time input position command counter	Command unit	Display the position command counter before the electronic gear ratio frequency multiplication, regardless of the current state of the servo and the control mode

## 5.2 Common operations



Warning

- Please check whether the wiring of the drive is correct before powering on.
- Make sure that the motor is not loaded to prevent collision or other hazards.

### 5.2.1 JOG mode operation

When using the jog function, you need to cancel the servo enable first, or you can't enter the JOG state!

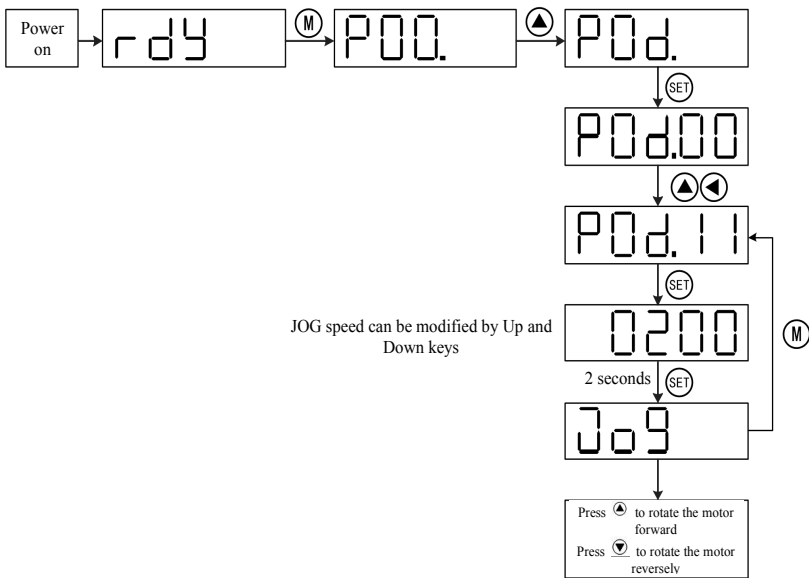

### 5.2.2 Internal power-up enable

If you want to power on and enable the motor when the DI1 terminal is not connected externally, you can set P03-03 (DI1 level logic) to 1, and the motor will be enabled by default after the power is turned on again.

### 5.2.3 Initialization parameters

Set P02-31 to 1 to initialize the drive parameters, and the drive needs to be restarted after the setting is completed.

### 5.2.4 Manual reset alarm

Set P0D-01 to 1 to clear the resettable alarms;

For multi-turn absolute encoder power failure alarm (Er.731), first set P0D-20 to 2, and then set P0D-01 to 1 to clear the alarm.

# Chapter VI Control Mode Description

## 6.1 Location mode description

### 6.1.1 Position mode wiring diagram

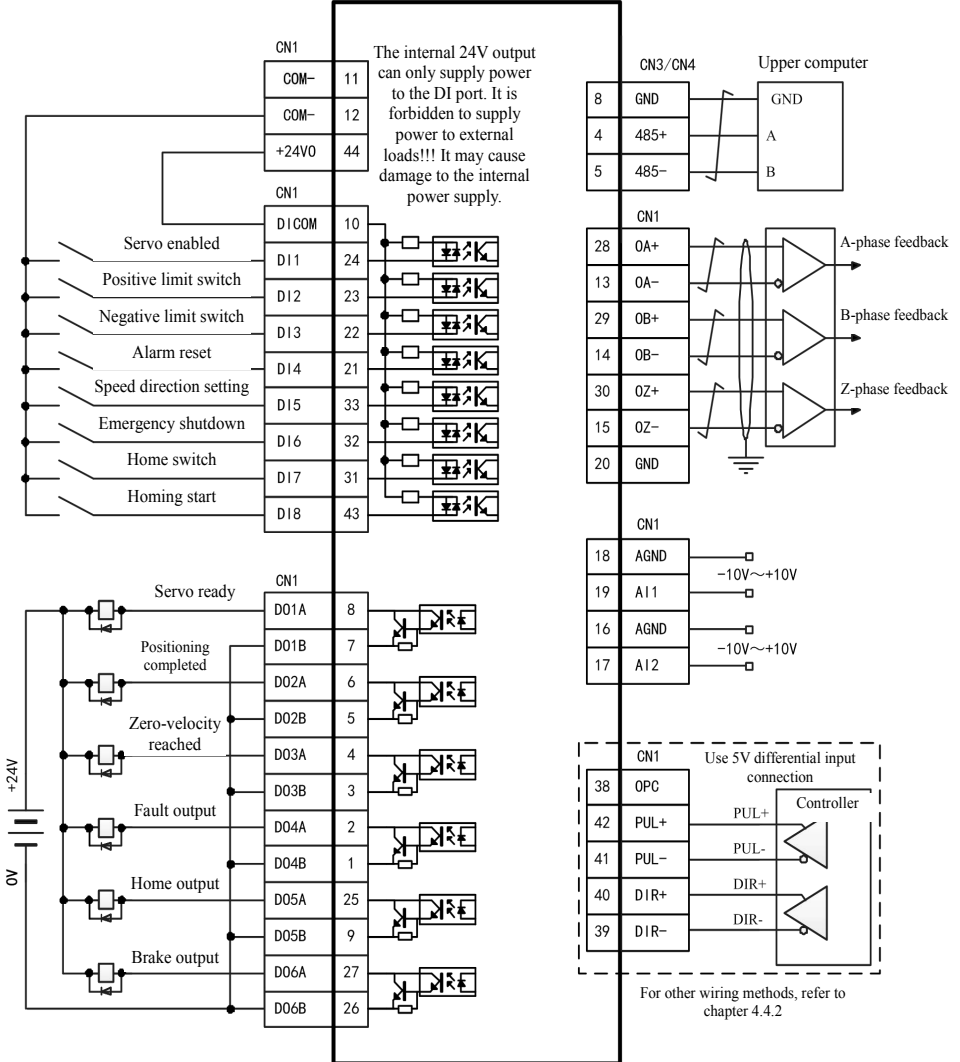

## 6.1.2 Parameters related to external pulse control

### 1. Pulse pin

Signal name	Corresponding CN1 pin number	Name	Note or supplementary instructions
PUL+	42	Pulse input positive	1. Please read chapter 4.4.2 carefully before wiring to prevent wrong wiring from damaging the drive. 2. The maximum pulse frequency is 1MHz, and the duty cycle is 50%.
PUL-	41	Pulse input negative	
DIR+	40	Pulse direction negative	
DIR-	39	Pulse direction positive	
OPC	38	24V pulse common terminal	

### 2. Related parameters

No.	Parameter name	Setting range	Functions
P02-00	Control mode selection	0~6	Corresponding to position mode when set to 1
P02-01	Absolute value system selection	0~2	0: Incremental encoder, 1: Absolute value encoder
P2-02	Rotation direction	0~1	0: Forward; 1: Reverse
P02-03	Output pulse phase	0~1	Feedback pulse direction, 0: Forward; 1: Reverse
P05-00	Position command source	0~2	When set to 0, it is controlled by external pulse command
P05-02	The number of pulses per motor rotation	0 ~1048576	
P05-07	Electronic gear ratio 1 (numerator)	1~1073741824	The gear ratio takes effect only when P05-02 is set to 0 Number of pulses per revolution $= \frac{\text{Encoder resolution} \times \text{Denominator of electronic gear ratio}}{\text{Numerator of electronic gear ratio}}$ 17-bit encoder is 131072 pulses/revolution; 23-bit encoder is 8388608 pulses/revolution.
P05-09	Electronic gear ratio 1 (denominator)	1~1073741824	
P05-15	Pulse command form		0: Pulse + direction, positive logic; 1: Pulse + direction, negative logic; 3: A-phase + B-phase quadrature pulse, quadruplicated frequency 4: CW+CCW
P05-17	Encoder frequency division pulse number	35 ~32767	
P05-38	Servo pulse output source selection	0~2	0: Encoder frequency division output; 1: Pulse command synchronous output; 2: Frequency division or synchronous output prohibited
P05-43	Position pulse edge selection	0~1	0: Active on falling edge; 1: Active on rising edge
P03-03	DI1 terminal logic selection	0~4	When set to 1, <b>the default is power-on enable state</b>

## 6.1.3 Parameters related to internal multi-segment position control

### 1. Related DI functions can be controlled by external DI, or through virtual VDI for communication control

DI function code	Symbol	Function name	Function description
FunIN.4	CMD-SEL	Main and auxiliary running command switching	Inactive - the current running command is A; Active - the current running command is B
FunIN.6	CMD1	Multi-segment command switching 1	16-segment command selection.
FunIN.7	CMD2	Multi-segment command switching 2	16-segment command selection.
FunIN.8	CMD3	Multi-segment command switching 3	16-segment command selection.
FunIN.9	CMD4	Multi-segment command switching 4	16-segment command selection.
FunIN.27	POSDirSel	Position command direction setting	Active - the actual direction is opposite to the set direction;

FunIN.28	PosInSen	Multi-segment position command enable	Active - enable internal multi-segment position.
----------	----------	---------------------------------------	--

## 2. Related parameters

No.	Parameter name	Setting range	Functions
P05-00	Position command source	0~2	When set to 2, it is internal multi-segment position control mode
P11-00	Multi-segment position operation mode	0~3	0: Stop after a single operation; 1: Cyclic operation; 2: DI switching operation; 3: Sequential operation
P11-01	Number of segments at end point of displacement command	1~16	
P11-02	Margin processing method	0~1	0: Continue to run the unfinished segment; 1: Restart operation
P11-03	Time unit	0~1	0:ms; 1: s
P11-04	Displacement command type selection	0~1	0: Relative displacement command; 1: Absolute displacement command
P11-05	Sequential operation start segment selection	0~16	Select the start segment of internal position sequence operation
P11-12	1st segment movement displacement	-1073741824 ~1073741824	1st segment movement displacement
P11-14	The maximum running speed of the 1st segment displacement	1~6000	The maximum running speed of the 1st segment displacement
P11-15	1st segment displacement acceleration and deceleration time	0~65535	1st segment displacement acceleration and deceleration time
P11-16	Waiting time after the 1st segment displacement is completed	0~10000	Waiting time after the 1st segment displacement is completed
.....			
P11-87	16th segment movement displacement	-1073741824 ~1073741824	16th segment movement displacement
P11-89	The maximum running speed of the 16th segment displacement	1~6000	The maximum running speed of the 16th segment displacement
P11-90	16th segment displacement acceleration and deceleration time	0~65535	16th segment displacement acceleration and deceleration time
P11-91	Waiting time after the 16th segment displacement is completed	0~10000	Waiting time after the 16th segment displacement is completed
P0C-09	Communication VDI	0~1	0: Disable; 1: Enable

## 3. The combination method when using the DI port to switch the internal multi-segment position

Segment No.	DI port combination mode				Movement displacement	Max speed	Acceleration and deceleration Time	Wait time after segment
	CMD1	CMD2	CMD3	CMD4				
1	0	0	0	0	P11-12	P11-14	P11-15	P11-16
2	0	0	0	1	P11-17	P11-19	P11-20	P11-21
3	0	0	1	0	P11-22	P11-24	P11-25	P11-26
4	0	0	1	1	P11-27	P11-29	P11-30	P11-31
5	0	1	0	0	P11-32	P11-34	P11-35	P11-36
6	0	1	0	1	P11-37	P11-39	P11-40	P11-41
7	0	1	1	0	P11-42	P11-44	P11-45	P11-46
8	0	1	1	1	P11-47	P11-49	P11-50	P11-51
9	1	0	0	0	P11-52	P11-54	P11-55	P11-56
10	1	0	0	1	P11-57	P11-59	P11-60	P11-61
11	1	0	1	0	P11-62	P11-64	P11-65	P11-66
12	1	0	1	1	P11-67	P11-69	P11-70	P11-71
13	1	1	0	0	P11-72	P11-74	P11-75	P11-76

14	1	1	0	1	P11-77	P11-79	P11-80	P11-81
15	1	1	1	0	P11-82	P11-84	P11-85	P11-86
16	1	1	1	1	P11-87	P11-89	P11-90	P11-91

## 6.2 Speed mode description

### 6.2.1 Speed mode wiring diagram

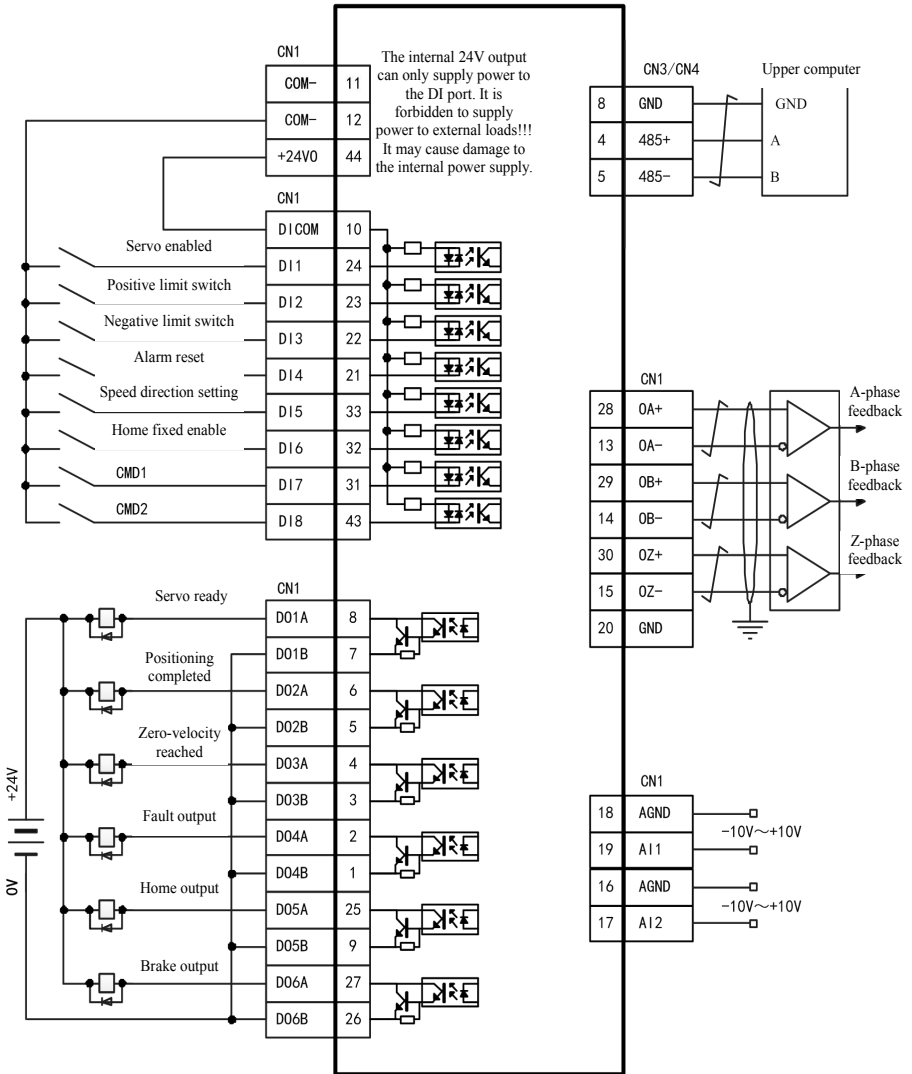



**Note:** The DI and DO functions in this wiring diagram are not the default configuration, and need to be modified according to the parameters in the DI/DO port function configuration table in 6.2.2.

## 6.2.2 Functions related to external speed mode

### 1. DI/DO port function configuration

No.	Parameter name	Set value	Functions
P03-12	DI6 terminal function selection	12	DI6 is defined as zero fixed enable
P03-14	DI7 terminal function selection	6	DI7 is defined as multi-segment running command switching 1
P03-16	DI8 terminal function selection	7	DI8 is defined as multi-segment running command switching 2
P04-08	DO5 terminal function selection	19	DO5 is defined as speed reaching output

### 2. Relevant pin wiring

Signal name	Corresponding CN1 pin number	Name	Note or supplementary instructions
AGND	18	Analog ground	Can input $\pm 10V$ analog voltage as speed command input or torque limit command input.
A11	19	Analog input 1	
AGND	16	Analog ground	
A12	17	Analog input 2	

### 3. Related parameters

No.	Parameter name	Setting range	Functions
P02-00	Control mode selection	0~6	Corresponding to speed mode when set to 0
P03-36	A11 offset	-5000~5000	Set A11 channel analog offset value, unit: mv
P03-37	A11 input filter time constant	0~655.35	Set A11 analog average filter time constant, unit: ms
P03-39	A11 dead zone	0~1000.0	Set A11 channel analog dead zone value; when the input voltage is less than the set voltage, the motor speed is zero, unit: mv
P03-40	A11 zero drift	-500.0~500.0	Set A11 channel analog zero drift value, unit: mv
P03-41	A12 offset	-5000~5000	Set A12 channel analog offset value, unit: mv
P03-42	A12 input filter time constant	0~655.35	Set A12 analog average filter time constant, unit: ms
P03-44	A12 dead zone	0~1000.0	Set A12 channel analog dead zone value; when the input voltage is less than the set voltage, the motor speed is zero, unit: mv
P03-45	A12 zero drift	-500.0~500.0	Set A12 channel analog zero drift value, unit: mv
P03-51	Corresponding speed value of analog 10V	0rpm~9000rpm	Set the corresponding motor output speed at analog 10V, unit: rpm
P03-52	Corresponding torque value of analog 10V	1.00~8.00 times	Set the corresponding motor output torque at analog 10V
P06-00	Main speed command A source	0~2	Select the source of main speed command A
P06-01	Auxiliary speed command B source	0~5	Select the source of auxiliary speed command B
P06-02	Speed command selection	0~4	Select the source of speed command
P06-03	Speed command keyboard setting value	-6000~6000	Set the value of the internal speed command, the precision is 1rpm
P06-05	Speed command acceleration ramp time constant	0~65535	Speed mode acceleration time, unit: ms (multi-speed command is inactive)
P06-06	Speed command deceleration ramp time constant	0~65535	Speed mode deceleration time, unit: ms (multi-speed command is inactive)
P06-07	Maximum speed threshold	0~6000	Set the maximum speed threshold
P06-08	Forward speed threshold	0~6000	Set the forward speed threshold
P06-09	Reverse speed threshold	0~6000	Set the reverse speed threshold
P06-15	Zero fixed speed threshold	0~6000	Set zero speed signal detection threshold
P06-16	Motor rotation speed threshold	0~1000	Set motor selection speed threshold
P06-17	Speed coincidence signal	0~100	Set speed coincidence detection signal threshold

	threshold		
P06-18	Speed reach signal threshold	10~6000	Set speed reach signal threshold
P06-19	Zero-speed output signal threshold	1~6000	Set zero-speed output signal threshold

### 6.2.3 Internal multi-speed related functions

#### 1. Related DI functions can be controlled by external DI, or through virtual VDI for communication control

DI function code	Symbol	Function name	Function description
FunIN.4	CMD-SEL	Main and auxiliary running command switching	Inactive - the current running command is A; Active - the current running command is B
FunIN.5	DIR-SEL	Multi-speed DI switching direction	Active - command reverse direction
FunIN.6	CMD1	Multi-segment running command switching 1	16-segment command selection.
FunIN.7	CMD2	Multi-segment running command switching 2	16-segment command selection.
FunIN.8	CMD3	Multi-segment running command switching 3	16-segment command selection.
FunIN.9	CMD4	Multi-segment running command switching 4	16-segment command selection.

#### 2. Related parameters

No.	Parameter name	Setting range	Functions
P12-00	Multi-segment speed command operation mode	0~2	0- Stop after a single operation (P12-01 selects the number of segments) 1- Cycle operation (P12-01 selects the number of segments) 2- Switch via external DI
P12-01	Speed command end segment selection	1~16	
P12-02	Running time unit selection	0~1	0-sec; 1-min
P12-20	1st segment speed command	-6000~6000	
P12-21	1st segment running time	0~6553.5	
P12-22	1st segment acceleration and deceleration time	0~4	
.....			
P12-65	16th segment speed command	-6000~6000	
P12-66	16th segment running time	0~6553.5	
P12-67	16th segment acceleration and deceleration time	0~4	

#### 3. Combination method when using DI port to switch internal multi-speed

Segment No.	DI port combination mode				Internal speed	Running Time	Acceleration and deceleration Time
	CMD1	CMD2	CMD3	CMD4			
1	0	0	0	0	P12-20	P12-21	P12-22
2	0	0	0	1	P12-23	P12-24	P12-25
3	0	0	1	0	P12-26	P12-27	P12-28
4	0	0	1	1	P12-29	P12-30	P12-31
5	0	1	0	0	P12-32	P12-33	P12-34
6	0	1	0	1	P12-35	P12-36	P12-37
7	0	1	1	0	P12-38	P12-39	P12-40
8	0	1	1	1	P12-41	P12-42	P12-43
9	1	0	0	0	P12-44	P12-45	P12-46
10	1	0	0	1	P12-47	P12-48	P12-49
11	1	0	1	0	P12-50	P12-51	P12-52
12	1	0	1	1	P12-53	P12-54	P12-55

13	1	1	0	0	P12-56	P12-57	P12-58
14	1	1	0	1	P12-59	P12-60	P12-61
15	1	1	1	0	P12-62	P12-63	P12-64
16	1	1	1	1	P12-65	P12-66	P12-67

### 6.3 Torque mode description

#### 6.3.1 Torque mode wiring diagram

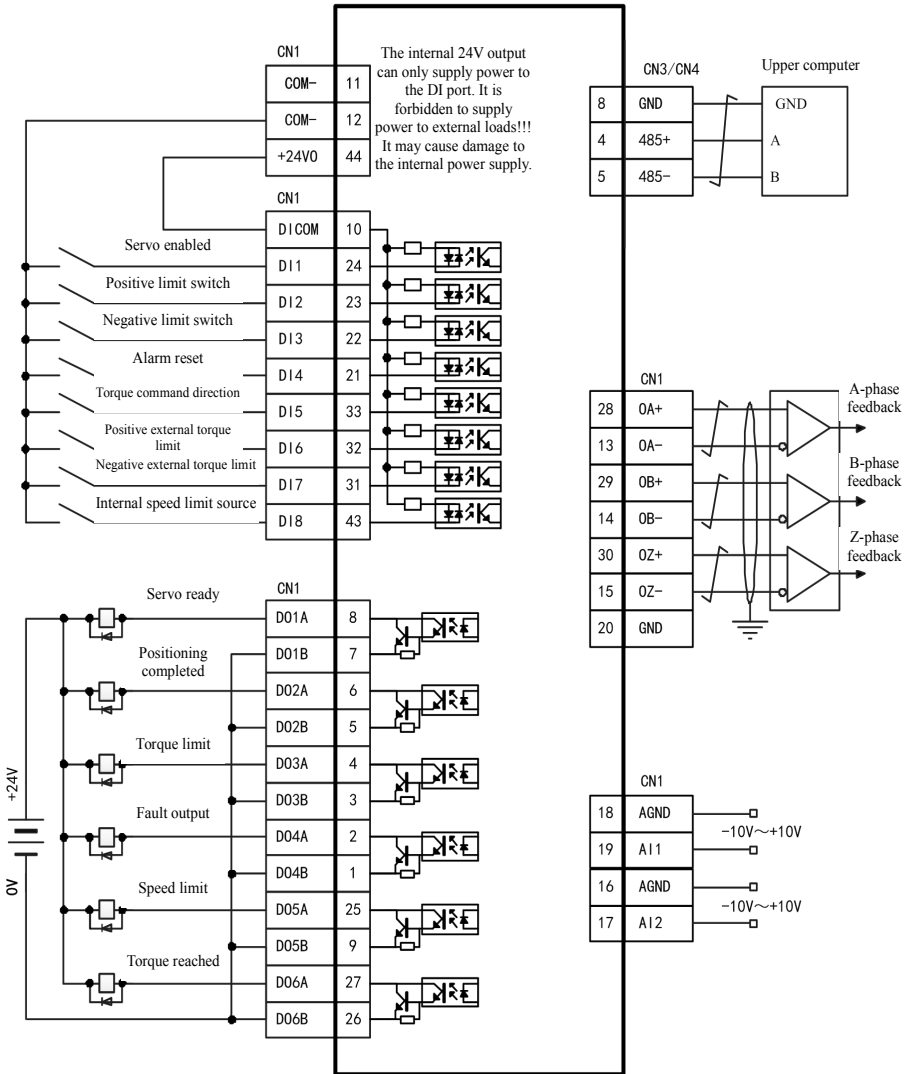

**Note:** The DI and DO functions in this wiring diagram are not the default configuration, and need to be modified according to the parameters in the DI/DO port function configuration table in 6.3.2.

### 6.3.2 Functions related to external torque mode

#### 1. DI/DO port function configuration

No.	Parameter name	Set value	Functions
P03-10	DI5 terminal function selection	25	DI5 is defined as torque command direction
P03-12	DI6 terminal function selection	16	DI6 is defined as positive external torque limit
P03-14	DI7 terminal function selection	17	DI7 is defined as negative external torque limit
P03-16	DI8 terminal function selection	36	DI8 is defined as internal speed limit source
P04-04	DO3 terminal function selection	7	DO3 is defined as torque limit output
P04-08	DO5 terminal function selection	8	DO5 is defined as speed limit output
P04-10	DO6 terminal function selection	18	DO6 is defined as torque reaching output

#### 2. Relevant pin wiring

Signal name	Corresponding CN1 pin number	Name	Note or supplementary instructions
AGND	18	Analog ground	±10V analog voltage can be input as torque command input or torque limit command input.
A11	19	Analog input 1	
AGND	16	Analog ground	
A12	17	Analog input 2	

#### 3. Related parameters

No.	Parameter name	Setting range	Functions
P02-00	Control mode selection	0~6	Corresponding to speed mode when set to 0
P03-50	A11 offset	-5000~5000	Set A11 channel analog offset value, unit: mv
P03-51	A11 input filter time constant	0~655.35	Set A11 analog average filter time constant, unit: ms
P03-53	A11 dead zone	0~1000.0	Set A11 channel analog dead zone; when the input voltage is less than the set voltage, the motor speed is zero, unit: mv
P03-54	A11 zero drift	-500.0~500.0	Set A11 channel analog zero drift value, unit: mv
P03-55	A12 offset	-5000~5000	Set A11 channel analog offset value, unit: mv
P03-56	A12 input filter time constant	0~655.35	Set A11 analog average filter time constant, unit: ms
P03-58	A12 dead zone	0~1000.0	Set A11 channel analog dead zone; when the input voltage is less than the set voltage, the motor speed is zero, unit: mv
P03-59	A12 zero drift	-500.0~500.0	Set A11 channel analog zero drift value, unit: mv
P03-80	Corresponding speed value of analog 10V	0rpm~9000rpm	Set the corresponding motor output speed at analog 10V, unit: rpm
P03-81	Corresponding torque value of analog 10V	1.00 ~ 8.00 times rated torque	Set the corresponding motor output torque at analog 10V
P07-00	Main torque command A source	0~2	Select the source of main torque command A

P07-01	Auxiliary torque command B source	0~2	Select the source of auxiliary torque command B
P07-02	Torque command selection	0~4	Select the source of torque command
P07-03	Torque command keyboard setting value	-300~300	Set the internal torque command for numerical setting

## Digital Servo Drive User Manual

P07-07	Torque limit source	0~4	Select the torque limit source
P07-08	T-LMT selection	1~2	Select the analog input channel of the torque limit signal
P07-09	Positive internal torque limit	0.0~300.0	Forward torque limit when setting internal torque
P07-10	Negative internal torque limit	0.0~300.0	Reverse torque limit when setting internal torque
P07-11	Positive external torque limit	0.0~300.0	Set the forward torque limit when setting external torque
P07-12	Negative external torque limit	0.0~300.0	Set the reverse torque limit when setting external torque
P07-17	Speed limit source selection	0~2	Select the source of speed limit in torque mode
P07-18	V-LMT selection	1~2	The analog channel when V-LMT is selected as the speed limit source
P07-19	Torque control forward speed limit value/torque control speed limit value 1	0~6000	Forward speed limit value in set torque mode/speed limit value 1 in set torque mode
P07-20	Negative speed limit value in torque control/speed limit value 2 in torque control	0~6000	Reverse speed limit value in set torque mode/speed limit value 2 in set torque mode
P07-21	Torque reaching reference value	0.0~300.0	Set torque reaching command reference value
P07-22	Torque reaching active value	0.0~300.0	Set the torque reaching command active offset threshold
P07-23	Torque reaching inactive value	0.0~300.0	Set the torque reaching command inactive offset threshold

## 6.4 Detailed description of DI/DO port function configuration

### 6.4.1 DI function description

1. DI port configuration parameters:

DI port	Function selection			Logic level	
	No.	Initial value	Function description	No.	Initial value
DI1	P03-02	1	Servo enabled	P03-03	0
DI2	P03-04	14	Positive overtravel switch	P03-05	0
DI3	P03-06	15	Reverse overtravel switch	P03-07	0
DI4	P03-08	2	Fault and warning reset	P03-09	0
DI5	P03-10	26	Speed command direction setting	P03-11	0
DI6	P03-12	34	Emergency shutdown	P03-13	0
DI7	P03-14	31	Home switch	P03-15	0
DI8	P03-16	32	Homing enable	P03-17	0

2. DI port function command table

Code	Name	Function name	Description	Remarks
FunIN.1	S-ON	Servo enabled	Inactive- Servo motor enable is prohibited; Active - Servo motor power-on enable.	The logic of the terminals must be set to: Active level. When the DI or VDI terminal corresponding to this function is changed, or the logic selection of the corresponding terminal is changed, the change will take effect after the power is turned on again.
FunIN.2	ALM-RST	Fault and warning reset (edge active function)	Inactive- disabled; Active - enabled.	The logic of the terminal must be set to: Edge active. If active level is selected, the drive is forced to set to edge active internally. According to the alarm type, the servo can continue to work after some alarms are reset. For NO.1 and NO.2 resettable fault, it is necessary to turn off the servo enable signal (S-ON is set to OFF) before using this function.

FunIN.3	GAIN-SEL	Gain switching	When P08-09=1: Inactive- The speed control loop is PI control; Active - The speed control loop is P control. When P08-09=2: Inactive- Fixed to first set of gains; Active - Fixed to second set of gains.	The logic selection of the corresponding terminal is recommended to be set as: Active level.
FunIN.4	CMD-SEL	Main and auxiliary running command switching	Inactive - the current running command is A; Active - The current run command is B.	The logic selection of the corresponding terminal is recommended to be set as: Active level.
FunIN.5	DIR-SEL	Multi-speed DI switching running direction setting	Inactive- Default command direction; Active- Command reverse direction.	The logic selection of the corresponding terminal is recommended to be set as: Active level.
FunIN.6	CMD1	Multi-segment running command switching 1	16-segment command selection.	The logic selection of the corresponding terminal is recommended to be set as: Active level.
FunIN.7	CMD2	Multi-segment running command switching 2	16-segment command selection.	The logic selection of the corresponding terminal is recommended to be set as: Active level.
FunIN.8	CMD3	Multi-segment running command switching 3	16-segment command selection.	The logic selection of the corresponding terminal is recommended to be set as: Active level.
FunIN.9	CMD4	Multi-segment running command switching 4	16-segment command selection.	The logic selection of the corresponding terminal is recommended to be set as: Active level.
FunIN.10	M1-SEL	Mode switching 1	Switch among speed, position and torque according to the selected control mode (3, 4, 5).	The logic selection of the corresponding terminal is recommended to be set as: Active level.
FunIN.11	M2-SEL	Mode switching 2	Switch among speed, position and torque according to the selected control mode (6).	The logic selection of the corresponding terminal is recommended to be set as: Active level.
FunIN.12	ZCLAMP	Home fixed enable	Active- Enable zero position fix function; Inactive- Disable zero position fix function.	The logic selection of the corresponding terminal is recommended to be set as: Active level.
FunIN.13	INHIBIT	Position command disable	Active - Prohibit command pulse input; Inactive- Allow command pulse input.	Internal and external position commands are prohibited from running. The logic selection of the terminal must be set as: active level.
FunIN.14	P-OT	Positive overtravel switch	Active- Prohibit forward drive; Inactive- Allow forward drive.	When the mechanical movement exceeds the movable range, it enters the overtravel prevention function: the logic selection of the corresponding terminal is recommended to set to: active level.
FunIN.15	N-OT	Reverse overtravel switch	Active - Prohibit reverse drive; Inactive- Allow reverse drive.	The logic selection of the corresponding terminal is recommended to be set as: Active level.
FunIN.16	P-CL	Positive external torque limit	Switch the torque limit source according to P07-07. When P07-07=1: Active- Forward external torque limit is active ; Inactive- Forward internal torque limit is active . P07-07=3 and the AI limit value is greater than the forward external limit value: Active- Forward external torque limit is active ; Inactive - AI torque limit is active . When P07-07=4: Active - AI torque limit is active ; Inactive- Forward internal torque limit is active .	The logic selection of the corresponding terminal is recommended to be set as: Active level.

FunIN.17	N-CL	Negative external torque limit	Switch the torque limit source according to P07-07. When P07-07=1: Active- Reverse external torque limit is active; Inactive- Reverse internal torque limit is active. P07-07=3 and the AI limit value is less than the reverse external limit value: Active- Reverse external torque limit is active. Inactive - AI torque limit is active . When P07-07=4: Active - AI torque limit is active ; Inactive- Reverse internal torque limit is active.	The logic selection of the corresponding terminal is recommended to be set as: Active level.
FunIN.18	JOGCMD+	Forward jog	Active- Input according to the given command; Inactive- Running command stops input.	The logic selection of the corresponding terminal is recommended to be set as: Active level.
FunIN.19	JOGCMD-	Negative jog	Active- Reverse input according to the given command; Inactive- Running command stops input.	The logic selection of the corresponding terminal is recommended to be set as: Active level.
FunIN.20	POSSTEP	Step size enable	Active- Execute the command of step size; Inactive- The command is zero, which is the positioning state.	The logic selection of the corresponding terminal is recommended to be set as: Edge active.
FunIN.21	HX1	Handwheel magnification signal 1	*10 times: HX1 is active, HX2 is inactive *100 times: HX1 is inactive , HX2 is active	The logic selection of the corresponding terminal is recommended to be set as: Active level.
FunIN.22	HX2	Handwheel magnification signal 2		
FunIN.23	HX_EN	Handwheel enable signal	Inactive- Select position control according to P05-00; Active- Receive handwheel pulse signal in location mode for position control.	The logic selection of the corresponding terminal is recommended to be set as: Active level.
FunIN.24	GEAR_SEL	Electronic gear selection	Inactive- Electronic gear ratio 1; Active- Electronic gear ratio 2.	The logic selection of the corresponding terminal is recommended to be set as: Active level.
FunIN.25	TOQDirSel	Torque command direction setting	Inactive- Positive direction; Active - Reverse direction.	The logic selection of the corresponding terminal is recommended to be set as: Active level.
FunIN.26	SPDDirSel	Speed command direction setting	Inactive- Positive direction; Active - Reverse direction.	The logic selection of the corresponding terminal is recommended to be set as: Active level.
FunIN.27	POSDirSel	Position command direction setting	Inactive, the actual position command direction is the same as the set position command direction; Active, the actual position command direction is opposite to the set position command direction;	The logic selection of the corresponding terminal is recommended to be set as: Active level.
FunIN.28	PosInSen	Multi-segment position command enable	Edge active Inactive- Ignore internal multi-segment commands; Active- Initiate internal multi-segment.	The logic selection of the corresponding terminal is recommended to be set as: Active level.
FunIN.29	XintFree	Interrupt fixed-length state release	Inactive- disabled; Active - enabled.	The logic selection of the corresponding terminal is recommended to be set to: Edge active.
FunIN.31	HomeSwitch	Home switch	Inactive- not trigger; Active - Trigger.	The logic selection of the corresponding terminal must be set to: active level. If it is set to 2 (rising edge active), the drive will be forced to change to 1 (high level active); If it is set to 3 (falling edge active), the drive will be forced to change to 0 (low level active); If it is set to 4 (both rising edge and falling edge active), the drive will be forced to change to 0 (low level active)
FunIN.32	HomingStart	Homing enable	Inactive- disabled; Active - enabled.	The logic selection of the corresponding terminal is recommended to be set to: Edge active.



FunIN.33	XintInhibit	Interrupt fixed length disable	Active - Prohibit interrupt fixed length; Inactive- Allow interrupt fixed length.	The logic selection of the corresponding terminal must be set to: active level. If it is set to 2 (rising edge active), the drive will be forced to change to 1 (high level active); If it is set to 3 (falling edge active), the drive will be forced to change to 0 (low level active); If it is set to 4 (both rising edge and falling edge active), the drive will be forced to change to 0 (low level active)
FunIN.34	Emergency Stop	Emergency shutdown	Active - Lock position after zero speed stop; Inactive- Has no effect on the current running state.	The logic selection of the corresponding terminal is recommended to be set as: Active level.
FunIN.35	ClrPosErr	Clear position deviation	Active - Position deviation is cleared; Inactive- Position deviation is not cleared.	The logic selection of the corresponding terminal is recommended to be set to: Edge active. It is recommended to configure this DI function to DI8 or DI9 terminal.
FunIN.36	V_LmtSel	Internal speed limit source	Active - P07-19 is used as internal positive and negative speed limit value (P07-17=2) Inactive- P07-20 is used as internal positive and negative speed limit value (P07-17=2)	The logic selection of the corresponding terminal is recommended to be set as: Active level.
FunIN.37	PulseInhibit	Pulse command prohibition	In position control mode, when the source of position command is pulse command (P05-00=0): Inactive- Respond to pulse commands; Active - Not respond to pulse commands;	The logic selection of the corresponding terminal is recommended to be set as: Active level.

## 6.4.2 DO function description

### 1. DO port configuration parameters:

DI port	Function selection			Logic level	
	No.	Initial value	Function description	No.	Initial value
DO1	P04-00	1	Servo ready	P04-01	0
DO2	P04-02	5	Positioning completed	P04-03	0
DO3	P04-04	3	Zero speed	P04-05	0
DO4	P04-06	11	Fault output	P04-07	0
DO5	P04-08	16	Homing output	P04-09	0
DO6	P04-10	9	Brake output	P04-11	0

### 2. DO port function command table

Code	Name	Function name	Description
FunOUT.1	S-RDY	Servo ready	Servo status is ready to receive S-ON active signal: Active - Servo is ready; Inactive- Servo is not ready.
FunOUT.2	TGON	Motor rotation output	Inactive, the absolute value of the motor speed after filtering is less than the set value of function code P06-16; Active, the absolute value of the motor speed after filtering reaches the set value of function code P06-16.
FunOUT.3	ZERO	Zero speed	Inactive, when the speed feedback of the motor is greater than the value set by function code P06-19; Active, when the difference between the speed feedback of the motor and the given value is greater than the value set by function code P06-19.

FunOUT.4	V-CMP	Speed coincidence	In speed control, it is active when the absolute value of the difference between the speed of the servo motor and the speed command is less than the set value of P06-17 speed deviation.
FunOUT.5	COIN	Positioning completed	In position control, it is active when the position deviation pulse reaches the positioning completion range P05-21.
FunOUT.6	NEAR	Positioning approach	In position control, it is active when the position deviation pulse reaches the setting of the positioning approach signal amplitude P05-22.
FunOUT.7	C-LT	Torque limit	Confirmation signal of torque limit: Active - motor torque is limited; Inactive - motor torque is not limited.
FunOUT.8	V-LT	Speed limit	Acknowledgement signal of speed limitation in torque control: Active - Motor speed is limited; Inactive - Motor speed is not limited.
FunOUT.9	BK	Brake output	Brake signal output: Valid - close, release the brake; Invalid - Activate the brake.
FunOUT.10	WARN	Warning output	Warning output signal is active. (On)
FunOUT.11	ALM	Fault output	Status active when a fault is detected.
FunOUT.12	ALMO1	Outputs 3-digit alarm code	Outputs 3-digit alarm code.
FunOUT.13	ALMO2	Outputs 3-digit alarm code	Outputs 3-digit alarm code.
FunOUT.14	ALMO3	Outputs 3-digit alarm code	Outputs 3-digit alarm code.
FunOUT.15	Xintcoin	Interrupt fixed length completion	Active - Interrupt fixed length positioning completed; Inactive - Interrupt fixed length positioning is not completed.
FunOUT.16	HomeAttain	Homing output	Homing status: Active - Homing; Inactive - Home is not reset.
FunOUT.17	ElecHome Attain	Electrical homing output	Electrical homing status: Active - Electrical home is reset; Inactive - Electrical home is not reset.
FunOUT.18	ToqReach	Torque reaching output	Active - The absolute value of torque reaches the set value; Inactive - The absolute value of torque is less than the set value.
FunOUT.19	V-Arr	Speed reaching output	Active - Speed feedback reaches the set value; Inactive - Speed feedback does not reach the set value.
FunOUT.20	AngIntRdy	Angle identification output	Active - Angle identification completed Inactive - Angle identification not completed
FunOUT.21	DB	DB brake output	Active - Dynamic brake relay disconnected Inactive - Dynamic brake relay pickup
FunOUT.22	CmdOk	Internal command output	Active - Internal command completed Inactive - Internal command not completed

## Chapter VII Parameter Description

### 7.1 P01 set drive parameters

Functional code	Name	Setting range	Unit	Default setting	Effective method	setting method	Related mode
P01-00	MCU software version	0-65535	-	-	-	Display	-
P01-01	Reserved	0-65535	-	-	-	Display	-
P01-02	Servo drive number	0-65535	-	-	Power on again	Stop setting	-

### 7.2 P02 set basic control parameters

Functional code	Name	Setting range	Unit	Default setting	Effective method	setting method	Related mode
P02-00	Control mode selection	0: Speed mode 1: Position mode 2: Torque mode 3: Torque mode ↔ speed mode 4: Speed mode ↔ position mode 5: Torque mode ↔ position mode 6: Torque ↔ speed ↔ position hybrid mode	-	1	Effective immediately	Stop setting	-
P02-01	Encoder type selection	0: Incremental encoder 1: Absolute value encoder	-	0	Power on again	Stop setting	ALL
P02-02	Rotation direction selection	0: CCW direction is the forward rotation direction (A leads B) 1: CW direction is the forward rotation direction (A lags B)	-	0	Power on again	Stop setting	PST
P02-03	Output pulse phase	0: CCW direction is the forward rotation direction (A leads B) 1: CW direction is the forward rotation direction (reverse mode, A lags B)	-	0	Power on again	Stop setting	PST
P02-05	Servo enable OFF stop mode selection	0: Free stop, keep free running state 1: Stop at zero speed, keep free running state	-	0	Effective immediately	Stop setting	PST
P02-06	Fault No.2 stop mode selection	0: Free stop, keep free running state 1: Stop at zero speed, keep free running state	-	0	Effective immediately	Stop setting	PST
P02-07	Overtravel stop mode selection	0: Free stop, keep free running state 1: Stop at zero speed, position remains locked 2: Stop at zero speed, keep free running state	-	1	Effective immediately	Stop setting	PST
P02-08	Fault No.1 stop mode selection	0: Free stop, keep free running state	-	0	Effective immediately	Stop setting	PST
P02-09	Brake output ON to command receiving delay	0-500	ms	250	Effective immediately	Running setting	PS
P02-10	Standstill state, delay time from brake output OFF to motor power off	1-1000	ms	150	Effective immediately	Running setting	PS
P02-11	Rotating state, speed threshold value when brake output is OFF	0-3000	rpm	30	Effective immediately	Running setting	PS
P02-12	Rotating state, delay time from servo enable OFF to brake output OFF	1-1000	ms	500	Effective immediately	Running setting	PS
P02-15	LED warning display selection	0: Output warning information immediately 1: Do not output warning information	-	0	Effective immediately	Stop setting	PST
P02-18	Servo enable (S-ON) Filtering time constant	0-64	ms	0	Effective immediately	Stop setting	PST
P02-21	Minimum braking resistance allowed by the drive	-	Ω	-	-	Display	PST
P02-22	Power of built-in braking resistor	-	W	-	-	Display	PST
P02-23	Resistance of built-in braking resistor	-	Ω	-	-	Display	PST

P02-24	Resistor heat dissipation coefficient	10-100	%	30	Effective immediately	Stop setting	PST
P02-25	Braking resistor setting	0: Use built-in braking resistor 1: Use external braking resistor, natural cooling 2: Use external braking resistor, forced air cooling 3: No braking resistor, rely on capacitor absorption	-	0	Effective immediately	Stop setting	PST
P02-26	Power of external braking resistor	1-65535	W	-	Effective immediately	Stop setting	PST
P02-27	Resistance of external braking resistor	1-1000	Ω	-	Effective immediately	Stop setting	PST
P02-31	Initialize system parameters	0: No operation 1: Restore default value (except P00/P01 set) 2: Clear fault records	-	0	Effective immediately	Stop setting	PST
P02-32	Panel default display function	0-99	-	50	Effective immediately	Running setting	-
P02-38	Fault short circuit braking time	0-30000	ms	5000	Effective immediately	Running setting	PST
P02-39	Fault short circuit braking threshold	0-3000	0.1%	1000	Effective immediately	Running setting	PST
P02-41	Factory parameter password	0-65535	-	0	Power on again	Stop setting	PST

### 7.3 P03 set terminal input parameters

Functional code	Name	Setting range	Unit	Default setting	Effective method	Setting method	Related mode
P03-00	Power-on valid DI functions Assignment 1	0-0xFFFF Bit0- Corresponding to FunIN.1 Bit1- Corresponding to FunIN.2 ..... Bit15- Corresponding to FunIN.16	-	0	Power on again	Running setting	-
P03-01	Power-on valid DI functions Assignment 2	0-0xFFFF Bit0- Corresponding to FunIN.17 Bit1- Corresponding to FunIN.18 ..... Bit15- Corresponding to FunIN.32	-	0	Power on again	Running setting	-
P03-02	DI1 terminal function selection	0-37	-	14	Effective at stop	Running setting	-
P03-03	DI1 terminal logic selection	Input polarity: 0-4 0- Means active low 1- Means active high 2- Means active on rising edge 3- Means active on falling edge 4- Means active on both rising and falling edges	-	0	Effective at stop	Running setting	-
P03-04	DI2 terminal function selection	0-37	-	15	Effective at stop	Running setting	-
P03-05	DI2 terminal logic selection	Refer to the description of P03-03	-	0	Effective at stop	Running setting	-
P03-06	DI3 terminal function selection	0-37	-	13	Effective at stop	Running setting	-
P03-07	DI3 terminal logic selection	Refer to the description of P03-03	-	0	Effective at stop	Running setting	-
P03-08	DI4 terminal function selection	0-37	-	2	Effective at stop	Running setting	-
P03-09	DI4 terminal logic selection	Refer to the description of P03-03	-	0	Effective at stop	Running setting	-
P03-10	DI5 terminal function selection	0-37	-	1	Effective at stop	Running setting	-
P03-11	DI5 terminal logic selection	Refer to the description of P03-03	-	0	Effective at stop	Running setting	-
P03-12	DI6 terminal function selection	0-37	-	12	Effective at stop	Running setting	-
P03-13	DI6 terminal logic selection	Refer to the description of P03-03	-	0	Effective at stop	Running setting	-
P03-14	DI7 terminal function selection	0-37	-	3	Effective at stop	Running setting	-
P03-15	DI7 terminal logic selection	Refer to the description of P03-03	-	0	Effective at stop	Running setting	-
P03-16	DI8 terminal function selection	0-37	-	31	Effective at stop	Running setting	-

P03-17	DI8 terminal logic selection	Refer to the description of P03-03	-	0	Effective at stop	Running setting	-
P03-34	Power-on valid DI functions Assignment 3	0-0xFFFF Bit0- Corresponding to FunIN.33 Bit1- Corresponding to FunIN.34 ..... Bit15- Corresponding to FunIN.48	-	0	Power on again	Running setting	-
P03-35	Power-on valid DI functions Assignment 4	0-0xFFFF Bit0- Corresponding to FunIN.49 Bit1- Corresponding to FunIN.50 ..... Bit15- Corresponding to FunIN.64	-	0	Power on again	Running setting	-
P03-50	AI1 offset	-5000~5000	mV	0	Effective immediately	Running setting	-
P03-51	AI1 input filter time Constant	0~655.35	ms	2.00	Effective immediately	Running setting	-
P03-53	AI1 dead zone	0~1000.0	mV	10.0	Effective immediately	Running setting	-
P03-54	AI1 zero drift	-500.0~500.0	mV	0.0	Effective immediately	Running setting	-
P03-55	AI2 offset	-5000~5000	mV	0	Effective immediately	Running setting	-
P03-56	AI2 input filter time Constant	0~655.35	ms	2.00	Effective immediately	Running setting	-
P03-58	AI2 dead zone	0~1000.0	mV	10.0	Effective immediately	Running setting	-
P03-59	AI2 zero drift	-500.0~500.0	mV	0.0	Effective immediately	Running setting	-
P03-80	Analog 10V corresponding speed value	0rpm~9000rpm	1rpm	3000rpm	Effective immediately	Stop setting	-
P03-81	Analog 10V corresponding torque value	1.00 ~ 8.00 times rated torque	-	1.00	Effective immediately	Stop setting	-

## 7.4 P04 set terminal output parameters

Functional code	Name	Setting range	Unit	Factory setting	Effective method	Setting method	Related mode
P04-00	DO1 terminal function selection	Refer to chapter 6.4.2 0~22	-	1	Effective at stop	Running setting	-
P04-01	DO1 terminal logic selection	Output polarity reversal setting: 0~1 0- Output L low level when active (optocoupler is turned on) 1- Output H high level when active (optocoupler is turned off)	-	0	Effective at stop	Running setting	-
P04-02	DO2 terminal function selection	0~22	-	5	Effective at stop	Running setting	-
P04-03	DO2 terminal logic selection	Refer to the description of P04-01	-	0	Effective at stop	Running setting	-
P04-04	DO3 terminal function selection	0~22	-	3	Effective at stop	Running setting	-
P04-05	DO3 terminal logic selection	Refer to the description of P04-01	-	0	Effective at stop	Running setting	-
P04-06	DO4 terminal function selection	0~22	-	11	Effective at stop	Running setting	-
P04-07	DO4 terminal logic selection	Refer to the description of P04-01	-	0	Effective at stop	Running setting	-
P04-08	DO5 terminal function selection	0~22	-	16	Effective at stop	Running setting	-
P04-09	DO5 terminal logic selection	Refer to the description of P04-01	-	0	Effective at stop	Running setting	-
P04-10	DO6 terminal function selection	0~22	-	0	Effective at stop	Running setting	-
P04-11	DO6 terminal logic selection	Refer to the description of P04-01	-	0	Effective at stop	Running setting	-
P04-22	DO source selection	0~31, set the DO port to be controlled by the drive or P31-4	-	0	Effective immediately	Stop setting	-

## 7.5 P05 set position control parameters

Functional code	Name	Setting range	Unit	Default setting	Effective method	Setting method	Related mode
P05-00	Position command source	0- Pulse command 1- Step value given 2- Multi-segment position command given	-	0	Effective immediately	Stop setting	P

P05-02	Number of position commands per motor rotation	0 ~1048576	P/r	0	Power on again	Stop setting	P
P05-04	First-order low-pass filter time constant	0~6553.5	ms	0.0	Effective immediately	Stop setting	P
P05-05	Step amount	-9999 ~9999	Command Unit	50	Effective immediately	Stop setting	P
P05-06	Average filter time constant	0.0~128.0	ms	0.0	Effective immediately	Stop setting	P
P05-07	Electronic gear ratio 1 (numerator)	1~1073741824	-	1048576	Effective immediately	Running setting	P
P05-09	Electronic gear ratio 1 (denominator)	1~1073741824	-	10000	Effective immediately	Running setting	P
P05-11	Electronic gear ratio 2 (numerator)	1~1073741824	-	1048576	Effective immediately	Running setting	P
P05-13	Electronic gear ratio 2 (denominator)	1~1073741824	-	10000	Effective immediately	Running setting	P
P05-15	Pulse command form	0- Pulse + direction, positive logic 1- Pulse + direction, negative logic 2- A-phase + B-phase quadrature pulse, quadruplicated frequency 3- CW+CCW	-	0	Power on again	Stop setting	P
P05-16	Clear action selection	0- Servo enable OFF or clear position deviation when fault occurs 1- Clear position deviation pulse when fault or warning occurs 2- Enable OFF and clear position deviation through DI input ClrPosErr signal	-	0	Effective immediately	Stop setting	P
P05-17	Encoder frequency division pulse number	35 ~32767	P/r	2500	Power on again	Stop setting	-
P05-19	Speed feedforward control selection	0- No speed feedforward 1- Internal speed feedforward 2- Use AI1 as speed feedforward input 3- Use AI2 as speed feedforward input	-	1	Effective immediately	Stop setting	P
P05-20	Positioning complete output condition	0- Output when the absolute value of position deviation is less than P05-21 1- Output when the absolute value of the position deviation is less than P05-21 and the position command after filtering is 0 2- Output when the absolute value of the position deviation is less than P05-21 and the position command before filtering is 0 3- Output when the absolute value of the position deviation is less than the positioning completion/proximity threshold and the position command filter is 0, active at least within the time set by P05-60	-	0	Effective immediately	Running setting	P
P05-21	Positioning completion threshold	1 ~65535	Encoder Unit	734	Effective immediately	Running setting	P
P05-22	Positioning proximity threshold	1 ~65535	Encoder Unit	65535	Effective immediately	Running setting	P
P05-30	Homing enable control	0- Disable homing 1- Input HomingStart signal through DI to enable homing function 2- Input HomingStart signal through DI to enable electrical reset function 3- Start homing immediately after power-on 4- Start homing immediately 5- Start homing command 6- Use current position as the home 8- Through the DI input signal, enable current position as the home	-	0	Effective immediately	Running setting	P

P05-31	Homing mode	<p>0- Positive homing, deceleration point and home are home switch</p> <p>1- Reverse homing, deceleration point and home are home switch</p> <p>2- Positive homing, deceleration point and home are the motor Z signal</p> <p>3- Reverse homing, deceleration point and home are motor Z signal</p> <p>4- Positive homing, deceleration point is home switch, home is motor Z signal</p> <p>5- Reverse homing, deceleration point is home switch, home is motor Z signal</p> <p>6- Positive homing, deceleration point and home are positive overtravel switch</p> <p>7- Reverse homing, deceleration point and home are reverse overtravel switch</p> <p>8- Positive homing, deceleration point is forward overtravel switch, home is motor Z signal</p> <p>9- Reverse homing, deceleration point is reverse overtravel switch, home is motor Z signal</p> <p>10- Positive homing, deceleration point and home are mechanical limit positions</p> <p>11- Reverse homing, deceleration point and home are mechanical limit positions</p> <p>12- Positive homing, deceleration point is mechanical limit position, home is the motor Z signal</p> <p>13- Reverse homing, deceleration point is mechanical limit position, home is the motor Z signal</p>	-	0	Effective immediately	Stop setting	P
P05-32	Speed of high-speed search home switch signal	0~3000	rpm	100	Effective immediately	Running setting	P
P05-33	Speed of low-speed search home switch signal	0~1000	rpm	10	Effective immediately	Running setting	P
P05-34	Acceleration and deceleration time when searching for home	0~1000	ms	1000	Effective immediately	Stop setting	P
P05-35	Limit the time to find the home	0~65535	Through P5-63 setting	10000	Effective immediately	Stop setting	P
P05-36	Machine home offset	-1073741824~1073741824	Command Unit	0	Effective immediately	Stop setting	P
P05-38	Servo pulse output source selection	<p>0- Encoder frequency division output</p> <p>1- Pulse command synchronous output</p> <p>2- Prohibit frequency division or synchronization output</p>	-	0	Power on again	Stop setting	P
P05-39	Electronic gear ratio switching condition	<p>0- The position command (referring to only the unit) is 0, and switch after 2.5ms</p> <p>1- Real-time switching</p>	-	0	Effective immediately	Stop setting	P
P05-40	Offset of mechanical home and processing method when encountering limit	<p>0- P05-36 is the coordinate after homing, homing enable will be re-triggered to find home in reverse direction in case of limit</p> <p>1- P05-36 is the relative offset after homing, homing enable will be re-triggered to find home in reverse direction in case of limit</p> <p>2- P05-36 is the coordinate after homing, it will automatically perform homing in the reverse direction in case of limit</p> <p>3- P05-36 is the relative offset after homing, it will automatically perform homing in the reverse direction in case of limit</p>	-	0	Effective immediately	Stop setting	P
P05-43	Position pulse edge selection	<p>0- Active on falling edge</p> <p>1- Active on rising edge</p>	1	0	Power on again	Running setting	PST
P05-46	Absolute position linear mode position offset (lower 32 bits)	-2147483648~2147483647	Encoder unit	0	Power on again	Stop setting	PST

P05-48	Absolute position linear mode position offset (upper 32 bits)	-2147483648~2147483647	Encoder unit	0	Power on again	Stop setting	PST
P05-50	Absolute position rotation mode Mechanical gear ratio (numerator)	1-65535	1	65535	Effective immediately	Stop setting	ALL
P05-51	Absolute position rotation mode Mechanical gear ratio (denominator)	1-65535	1	1	Effective immediately	Stop setting	ALL
P05-52	The number of pulses for one rotation of the load in absolute position rotation mode (lower 32 bits)	0~ 4294967295	Encoder unit	0	Effective immediately	Stop setting	ALL
P05-54	The number of pulses for one rotation of the load in absolute position rotation mode (upper 32 bits)	0~ 127	Encoder unit	0	Effective immediately	Stop setting	ALL
P05-56	Trigger stop homing speed judgment threshold	0~1000	rpm	2	Effective immediately	Running setting	P
P05-58	Trigger stop homing torque limit	0~300.0	%	100.0%	Effective immediately	Running setting	P
P05-59	Positioning completion window time	0~30000	ms	1	Effective immediately	Running setting	P
P05-60	Positioning completion hold time	0~30000	ms	1	Effective immediately	Running setting	P
P05-61	Encoder frequency division pulse number (32 bits)	0~262143	P/r	0	Power on again	Stop setting	-
P05-63	Limit the selection of time unit for home search	0~2	-	0	Effective immediately	Stop setting	-

## 7.6 P06 set speed control parameters

Functional code	Name	Setting range	Unit	Factory setting	Effective method	Setting method	Related mode
P06-00	Main speed command A source	0- Given number (P06-03) 1-A11 2-A12	-	0	Effective immediately	Stop setting	S
P06-01	Auxiliary speed command B source	0- Given number (P06-03) 1-A11 2-A12 3-0 (no effect) 4-0 (no effect) 5- Multi-speed command	-	1	Effective immediately	Stop setting	S
P06-02	Speed command selection	0- Main speed command A source 1- Auxiliary speed command B source 2- A+B 3- A/B switching	-	0	Effective immediately	Stop setting	S
P06-03	Speed command keyboard setting value	-6000~6000	rpm	200	Effective immediately	Running setting	S
P06-04	Jog speed set value	0~6000	rpm	100	Effective immediately	Running setting	S
P06-05	Speed command acceleration ramp time constant	0~65535	ms	200	Effective immediately	Running setting	S
P06-06	Speed command deceleration ramp time constant	0~65535	ms	200	Effective immediately	Running setting	S
P06-07	Maximum speed threshold	0~6000	rpm	5000	Effective immediately	Running setting	S
P06-08	Forward speed threshold	0~6000	rpm	5000	Effective immediately	Running setting	S
P06-09	Reverse speed threshold	0~6000	rpm	5000	Effective immediately	Running setting	S
P06-11	Torque feedforward control selection	0- No torque feedforward 0- Internal torque feedforward	-	1	Effective immediately	Running setting	PS
P06-15	Zero fixed speed threshold	0~6000	rpm	10	Effective immediately	Running setting	S
P06-16	Motor rotation speed threshold	0~1000	rpm	20	Effective immediately	Running setting	S
P06-17	Speed coincidence signal threshold	0~100	rpm	10	Effective immediately	Running setting	S



P06-18	Speed reach signal threshold	10-6000	rpm	1000	Effective immediately	Running setting	S
P06-19	Zero-speed output signal threshold	1-6000	rpm	10	Effective immediately	Running setting	S

## 7.7 P07 set torque control parameters

Functional code	Name	Setting range	Unit	Factory setting	Effective method	Setting method	Related mode
P07-00	Main torque command A source	0- Given number (P07-03) 1-A11 2-A12	-	0	Effective immediately	Stop setting	T
P07-01	Auxiliary torque command B source	0- Given number (P07-03) 1-A11 2-A12	-	1	Effective immediately	Stop setting	T
P07-02	Torque command selection	0- Main torque command A source 1- Auxiliary torque command B source 2- Main command A source + auxiliary command B source 3- Main command A source/auxiliary command B source switching 4- Communication given	-	0	Effective immediately	Stop setting	T
P07-03	Torque command keyboard setting value	-300.0-300.0	%	0	Effective immediately	Running setting	T
P07-05	Torque command filter time constant	0-30.00	ms	0.79	Effective immediately	Running setting	PST
P07-06	Second torque command filter time constant	0-30.00	ms	0.79	Effective immediately	Running setting	PST
P07-07	Torque limit source	0- Positive and negative internal torque limit 1- Positive and negative external torque limit (selected by P-CL, N-CL) 2- T-LMT is used as external torque limit input 3- Use the minimum value of positive and negative external torque and external T-LMT as the torque limit (selected by P-CL, N-CL) 4- Switch between positive and negative internal torque limit and T-LMT torque limit (selected by P-CL, N-CL)	-	0	Effective immediately	Stop setting	PST
P07-08	T-LMT selection	1-A11 2-A12	-	2	Effective immediately	Stop setting	PST
P07-09	Positive internal torque limit	0.0-300.0	%	300.0	Effective immediately	Running setting	PST
P07-10	Negative internal torque limit	0.0-300.0	%	300.0	Effective immediately	Running setting	PST
P07-11	Positive external torque limit	0.0-300.0	%	300.0	Effective immediately	Running setting	PST
P07-12	Negative external torque limit	0.0-300.0	%	300.0	Effective immediately	Running setting	PST
P07-17	Speed limit source selection	0- Internal speed limit (speed limit during torque control) 1- Use V-LMT as external speed limit input 2- Select P07-19/ through FunN.36(V-SEL) P07-20 as internal speed limit	-	0	Effective immediately	Running setting	T
P07-18	V-LMT selection	1-A11 2-A12	-	1	Effective immediately	Running setting	T
P07-19	Torque control forward speed limit /torque control speed limit 1	0-6000	rpm	3000	Effective immediately	Running setting	T
P07-20	Torque control negative speed limit/torque control speed limit 2	0-6000	rpm	3000	Effective immediately	Running setting	T
P07-21	Torque reaching reference value	0.0-300.0	%	0.0	Effective immediately	Running setting	PST
P07-22	Torque reaching active value	0.0-300.0	%	20.0	Effective immediately	Running setting	PST
P07-23	Torque reaching inactive value	0.0-300.0	%	10.0	Effective immediately	Running setting	PST
P07-40	Speed limit window in torque mode	0.5-30.0	ms	1.0	Effective immediately	Running setting	T

## 7.8 P08 set gain parameters

Functional code	Name	Setting range	Unit	Factory setting	Effective method	Setting method	Related mode
P08-00	Speed loop gain	0.1~2000.0	Hz	25.0	Effective immediately	Running setting	PS
P08-01	Speed loop integral time constant	0.15~512.00	ms	31.83	Effective immediately	Running setting	PS
P08-02	Position loop gain	0.0~2000.0	Hz	40.0	Effective immediately	Running setting	p
P08-03	2nd speed loop gain	0.1~2000.0	Hz	40.0	Effective immediately	Running setting	PS
P08-04	2nd speed loop integral time constant	0.15~512.00	ms	40.00	Effective immediately	Running setting	PS
P08-05	2nd position loop gain	0.0~2000.0	Hz	64.0	Effective immediately	Running setting	P
P08-08	Second gain mode setting	0- First gain fixed, use external DI for P/P1 switching 1- 1- Use gain switching according to the conditions of P08-09	-	1	Effective immediately	Running setting	PST
P08-09	Gain switching condition selection	0- First gain fixed (PS) 1- Use external DI switch (PS) 2- Large torque command (PS) 3- Large speed command (PS) 4- Large rate of change in speed command (PS) 5- Speed command high and low speed threshold (PS) 6- Large position deviation (P) 7- With position command (P) 8- Positioning completed (P) 9- Actual speed is high (P) 10- With position command + actual speed (P)	-	0	Effective immediately	Running setting	PST
P08-10	Gain switching delay time	0.0~1000.0	ms	5.0	Effective immediately	Running setting	PST
P08-11	Gain switching level	0~20000	According to switch condition	50	Effective immediately	Running setting	PST
P08-12	Gain switching time lag	0~20000	According to switch condition	30	Effective immediately	Running setting	PST
P08-13	Position gain switching time	0.0~1000.0	ms	3.0	Effective immediately	Running setting	p
P08-15	Load inertia ratio	0.00~120.00	Times	1.00	Effective immediately	Running setting	PST
P08-18	Speed feedforward filter time constant	0.00~64.00	ms	0.50	Effective immediately	Running setting	P
P08-19	Speed feedforward gain	0.0~100.0	%	0.0	Effective immediately	Running setting	P
P08-20	Torque feedforward filter time constant	0.00~64.00	ms	0.50	Effective immediately	Stop setting	PS
P08-21	Torque feedforward gain	0.0~200.0	%	0.0	Effective immediately	Running setting	PS
P08-22	Velocity feedback filter options	0- Disable speed feedback average filtering 1- Speed feedback 2 times average filter 2- Speed feedback 4 times average filter 3- Speed feedback 8 times average filter 4- Speed feedback 16 times average filter	-	0	Effective immediately	Stop setting	PS
P08-23	Speed feedback low-pass filter cutoff frequency	100~4000	Hz	4000	Effective immediately	Running setting	PS
P08-24	Pseudo-differential feedforward control coefficient	0.0~100.0	-	100.0	Effective immediately	Running setting	PS

## 7.9 P09 set self-tuning parameters

Functional code	Name	Setting range	Unit	Default setting	Effective method	Setting method	Related mode
P09-01	Rigidity grade selection	0-31	-	12	Effective immediately	Running setting	PST
P09-02	Adaptive notch filter mode selection	0- Adaptive notch filter is no longer updated 1-1 adaptive notch filter active (3rd notch filter) 2-2 adaptive notch filters active (3rd and 4th notch filters) 3- Only test the resonance point, displayed in P09-24 4- Restore the values of the 3rd and 4th notch filters to the default	-	0	Effective immediately	Running setting	PST
P09-04	Low frequency resonance suppression mode selection	0- Manually set vibration frequency 1- Automatically identify vibration frequency	-	0	Effective immediately	Running setting	P
P09-05	Offline inertia identification mode selection	0- Positive and negative triangle wave mode 1- JOG mode	-	0	Effective immediately	Stop setting	PST
P09-06	Inertia identification maximum speed	100-1000	rpm	500	Effective immediately	Stop setting	PST
P09-07	Time constant of accelerate to maximum speed during inertia identification	20-800	ms	125	Effective immediately	Stop setting	PST
P09-08	Waiting time after a single inertia identification is completed	50-10000	ms	800	Effective immediately	Stop setting	PST
P09-09	Number of revolutions of the motor completing single inertia identification	0.00-2.00	r	-	-	Display	PST
P09-12	First notch filter frequency	50-4000	Hz	4000	Effective immediately	Running setting	PS
P09-13	First notch filter width class	0-20	-	2	Effective immediately	Running setting	PS
P09-14	First notch filter depth level	0-99	-	0	Effective immediately	Running setting	PS
P09-15	Second notch filter frequency	50-4000	Hz	4000	Effective immediately	Running setting	PS
P09-16	Second notch filter width level	0-20	-	2	Effective immediately	Running setting	PS
P09-17	Second notch filter depth level	0-99	-	0	Effective immediately	Running setting	PS
P09-18	Third notch filter frequency	50-4000	Hz	4000	Effective immediately	Running setting	PS
P09-19	Third notch filter width level	0-20	-	2	Effective immediately	Running setting	PS
P09-20	Third notch filter depth level	0-99	-	0	Effective immediately	Running setting	PS
P09-21	Fourth notch filter frequency	50-4000	Hz	4000	Effective immediately	Running setting	PS
P09-22	Fourth notch filter width class	0-20	-	2	Effective immediately	Running setting	PS
P09-23	Fourth notch filter depth level	0-99	-	0	Effective immediately	Running setting	PS
P09-24	Resonance frequency identification results	0-2	Hz	0	-	Display	PS
P09-30	Torque disturbance compensation gain	0.0-100.0	%	0.0	Effective immediately	Running setting	PS
P09-31	Torque disturbance observer filter time constant	0.00-25.00	ms	0.50	Effective immediately	Running setting	PS
P09-38	Low frequency resonant frequency	1.0-100.0	Hz	100.0	Effective immediately	Running setting	P
P09-39	Low frequency resonance frequency filter setting	0-10	-	2	Effective immediately	Running setting	P

## 7.10 P0A set fault and protection parameters

Functional code	Name	Setting range	Unit	Factory setting	Effective method	Setting method	Related mode
P0A-00	Power input phase loss protection selection	0- Enable fault and disable warning 1- Enable fault and warning 2- Disable fault and warning	-	0	Effective immediately	Running setting	-

P0A-03	Power-down save function enable selection	0- Do not execute power-down save 1- Execute power-down save	-	0	Effective immediately	Running setting	-
P0A-04	Motor overload protection gain	50-300	%	100	Effective immediately	Stop setting	-
P0A-08	Overspeed fault threshold	0-10000	rpm	0	Effective immediately	Running setting	PST
P0A-09	Maximum position pulse frequency	100-4000	kHz	4000	Effective immediately	Stop setting	P
Functional code	Name	Setting range	Unit	Factory setting	Effective method	Setting method	Related mode
P0A-10	Excessive position deviation fault threshold	1-1073741824	Encoder / Command unit	3145728	Effective immediately	Running setting	P
P0A-12	Overspeed protection function enable	0- No overspeed protection 1- Turn on overspeed protection	-	1	Effective immediately	Running setting	PST
P0A-16	Low frequency resonance position deviation judgment threshold	1-1000	Encoder unit	5	Effective immediately	Running setting	P
P0A-17	Position setting unit selection	0- Encoder unit 1- Command unit	-	0	Effective immediately	Stop setting	P
P0A-24	Low-speed pulse input pin filter time constant	0-255	25ns	30	Power on again	Stop setting	P
P0A-25	Speed feedback display value filter time constant	0-5000	ms	50	Effective immediately	Stop setting	-
P0A-26	Motor overload shield enable	0- Turn on motor overload detection 1- Shield motor overload warning and fault detection	-	0	Effective immediately	Stop setting	-
P0A-27	Speed DO filter time constant	0-5000	ms	10	Effective immediately	Stop setting	-
P0A-28	Quadrature encoder filter time constant	0-255	25ns	30	Power on again	Stop setting	-
P0A-30	High-speed pulse input pin filter time constant	0-255	25ns	3	Power on again	Stop setting	P
P0A-32	Stall overtemperature protection time window	10-65535	ms	200	Effective immediately	Running setting	-
P0A-33	Stall overtemperature protection enable	0- Shield motor stall overtemperature protection detection 1- Enable motor stall overtemperature protection detection	-	1	Effective immediately	Running setting	-
P0A-36	Encoder multi-turn overflow fault selection	0- No 1- Yes	-	0	Effective immediately	Shutdown setting	ALL
P0A-40	Software limit setting	0- Disable software limit 1- Enable software limit immediately after power on 2- Enable software limit after homing	1	0	Effective immediately	Stop setting	PST
P0A-41	Maximum value of software limit	-2147483648-2147483647	Command unit	2147483647	Effective immediately	Stop setting	PST
P0A-43	Minimum value of software limit	-2147483648-2147483647	Command unit	-2147483648	Effective immediately	Stop setting	PST
P0A-47	Brake protection detection enable	0- No 1- Yes	-	1	Effective immediately	Running setting	ALL
P0A-48	Gravity load detection value	0-300.0	%	30.0	Effective immediately	Running setting	ALL

### 7.11 P0B set monitoring parameters

Functional code	Name	Setting range	Unit	Factory setting	Effective method	Setting method	Related mode
P0B-00	Actual motor speed	-	rpm	-	-	Display	PST
P0B-01	Speed command	-	rpm	-	-	Display	PS
P0B-02	Internal torque command (Relative to rated torque)	-	%	-	-	Display	PST

P0B-03	Input signal (DI signal) monitoring	-	-	-	-	Display	PST
P0B-05	Output signal (DO signal) monitoring	-	-	-	-	Display	PST
P0B-07	Absolute position counter (32-bit decimal display)	-	Command unit	-	-	Display	PST
P0B-09	Mechanical angle (number of pulses from the home)	-	Encoder unit	-	-	Display	PST
P0B-10	Electrical angle	-	°	-	-	Display	PST
P0B-11	Corresponding speed information of input position command	-	rpm	-	-	Display	P
P0B-12	Average load ratio	-	%	-	-	Display	PST
P0B-13	Input command pulse counter (32-bit decimal display)	-	Command unit	-	-	Display	P
P0B-15	Encoder position deviation counter (32-bit decimal display)	-	Encoder unit	-	-	Display	P
P0B-17	Feedback pulse counter (32-bit decimal display)	-	Encoder unit	-	-	Display	PST
P0B-19	Total power-on time (32-bit decimal display)	-	s	-	-	Display	PST
P0B-21	AI1 sampling voltage value	-	V	-	-	Display	PST
P0B-22	AI2 sampling voltage value	-	V	-	-	Display	PST
P0B-24	Phase current rms value	-	A	-	-	Display	PST
P0B-26	Bus voltage value	-	V	-	-	Display	PST
P0B-27	Module temperature value	-	°C	-	-	Display	PST
P0B-33	Fault recording	0-Current fault 1-Last fault 2-Last two faults ..... 9- Last 9 faults	-	0	Effective immediately	Running setting	PST
P0B-34	Fault code of selected time	-	-	-	-	Display	PST
P0B-35	Selected fault timestamp	-	s	-	-	Display	PST
P0B-37	Motor speed at selected fault	-	rpm	-	-	Display	PST
P0B-38	Motor U-phase current at the selected fault	-	A	-	-	Display	PST
P0B-39	Motor V-phase current at the selected fault	-	A	-	-	Display	PST
P0B-40	Bus voltage at selected fault	-	V	-	-	Display	PST
P0B-41	Input terminal status at selected fault	-	-	-	-	Display	PST
P0B-42	Output terminal status at selected fault	-	-	-	-	Display	PST
P0B-53	Position deviation counter	-	Command unit	-	-	Display	P
P0B-55	Actual motor speed	0.1rpm	rpm	-	-	Display	PST
P0B-58	Mechanical absolute position (lower 32 bits)	-	Encoder unit	0	-	Display	ALL
P0B-60	Mechanical absolute position (upper 32 bits)	-	Encoder unit	0	-	Display	ALL
P0B-64	Real-time input position command counter	-	Command unit	-	-	Display	PST
P0B-70	Absolute value encoder rotation data	-	r	0	-	Display	ALL
P0B-71	Position within 1 revolution of absolute value encoder	-	Encoder Unit	0	-	Display	ALL
P0B-77	Absolute value encoder absolute position (lower 32 bits)	-	Encoder Unit	0	-	Display	ALL
P0B-79	Absolute value encoder absolute position (upper 32 bits)	-	Encoder Unit	0	-	Display	ALL
P0B-81	Rotating load single-turn position (lower 32 bits)	-	Encoder unit	0	-	Display	ALL
P0B-83	Rotating load single-turn position (upper 32 bits)	-	Encoder unit	0	-	Display	ALL
P0B-85	Rotating load single-turn position	-	Command unit	0	-	Display	ALL

## 7.12 P0C set communication parameters

Functional code	Name	Setting range	Unit	Factory setting	Effective method	Setting method	Related mode
P0C-00	Servo axis address	1-247, 0 is the broadcast address	-	1	Effective immediately	Running setting	PST

P0C-02	Serial port baud rate setting	0-2400bps 1-4800bps 2-9600bps 3-19200bps 4-38400bps 5-57600bps	-	5	Effective immediately	Running setting	PST
P0C-03	Moubus data format	0- No parity, 2 stop bits 1- Even parity, 1 stop bit 2- Odd parity, 1 stop bit 3- No parity, 1 stop bit	-	0	Effective immediately	Running setting	PST
P0C-09	Communication VDI	0- Disable 1- Yes	-	0	Effective immediately	Stop setting	PST
P0C-10	VDI default value after power-on	Bit0-VDI1 default value ..... Bit15-VDI16 default value	-	0	Power on again	Running setting	PST
P0C-11	Communication VDO	0- Disable 1- Yes	-	0	Effective immediately	Stop setting	PST
P0C-12	The default level when the VDO function is selected as 0	Bit0-VDO1 default value ..... Bit15-VDO16 default value	-	0	Effective immediately	Stop setting	PST
P0C-13	Whether the write function code of Moubus communication is updated to EEPROM	0- Do not update EEPROM 1- Update EEPROM except P0B set and P0D set	-	1	Effective immediately	Running setting	PST
P0C-14	Moubus error codes	0x0001 - Illegal command code 0x0002 - Illegal data address 0x0003 - Illegal data 0x0004 - Slave device failure	1	-	-	Display	-
P0C-25	Moubus command response delay	0-5000	ms	1	Effective immediately	Running setting	PST
P0C-26	Moubus communication data high and low order	0- High 16 bits first, low 16 bits last 1- Low 16 bits first, high 16 bits last	1	1	Effective immediately	Running setting	PST
P0C-30	Moubus error frame format selection	0- Old protocol 1- New protocol (standard)	1	1	Effective immediately	Running setting	PST

### 7.13 P0D set auxiliary function parameters

Functional code	Name	Setting range	Unit	Factory setting	Effective method	Setting method	Related mode
P0D-00	Software Reset	0- No operation 1- Yes	-	0	Effective immediately	Stop setting	-
P0D-01	Fault reset	0- No operation 1- Yes	-	0	Effective immediately	Stop setting	-
P0D-02	Offline inertia identification function	-	-	-	Effective immediately	Running setting	-
P0D-03	Initial angle recognition	1: Enable	-	-	-	-	-
P0D-05	Emergency shutdown	0- No operation 1- Enable emergency stop	-	0	Effective immediately	Running setting	-
P0D-10	Reserved	0-					
P0D-11	JOG test run function	(with built-in filter)	-	-	-	-	-
P0D-17	DIDO force input and output enable	0- No operation 1- Force DI to enable, force DO to disable 2- Force DO to enable, force DI to disable 3- Force all DIDOs to enable	-	0	Effective immediately	Running setting	-
P0D-18	DI forced to input given value	0-0x01FF	-	0x01FF	Effective immediately	Running setting	-
P0D-19	DO forced to output given value	0-0x001F	-	0	Effective immediately	Running setting	-
P0D-20	Absolute encoder reset enable	0- No operation 1- Reset fault and multi-turn data 2- Reset fault and multi-turn data	-	0	Effective immediately	Stop setting	ALL
P0D-24	Gravity load identification	0- No 1- Yes	-	0	Effective immediately	Running setting	-

## 7.14 P11 set multi-segment position function parameters

Functional code	Name	Setting range	Unit	Factory setting	Effective method	Setting method	Related mode
P11-00	Multi-segment position operation mode	0: Stop after a single operation; (P11-01 selects the number of segments) 1- Cycle operation (P11-01 selects the number of segments) 2-DI switch operation (Selected by DI) 3- Sequence operation (P11-01 selects the number of segments)	-	1	Effective immediately	Stop setting	P
P11-01	Number of segments at end point of displacement command	1~16	-	1	Effective immediately	Stop setting	P
P11-02	Margin processing method	Valid in other three modes except DI mode 0-Continue to run the unfinished segment 1- Restart operation from segment 1	-	0	Effective immediately	Stop setting	P
P11-03	Time unit	0-ms 1-s	-	0	Effective immediately	Stop setting	P
P11-04	Displacement command type selection	0- Relative displacement command 1- Absolute displacement command	-	0	Effective immediately	Stop setting	P
P11-05	Sequential operation start segment selection	0~16	-	0	Effective immediately	Stop setting	P
P11-12	1st segment movement displacement	-1073741824 ~1073741824	Command unit	10000	Effective immediately	Running setting	P
P11-14	The maximum running speed of the 1st segment displacement	1~6000	rpm	200	Effective immediately	Running setting	P
P11-15	1st segment displacement acceleration and deceleration time	0~65535	ms(s)	10	Effective immediately	Running setting	P
P11-16	Waiting time after the 1st segment displacement is completed	0~10000	ms(s)	10	Effective immediately	Running setting	P
P11-17	2nd segment movement displacement	-1073741824 ~1073741824	Command unit	10000	Effective immediately	Running setting	P
P11-19	The maximum running speed of the 2nd segment displacement	1~6000	rpm	200	Effective immediately	Running setting	P
P11-20	2nd segment displacement acceleration and deceleration time	0~65535	ms(s)	10	Effective immediately	Running setting	P
P11-21	Waiting time after the 2nd segment displacement is completed	0~10000	ms(s)	10	Effective immediately	Running setting	P
P11-22	3rd segment movement displacement	-1073741824 ~1073741824	Command unit	10000	Effective immediately	Running setting	P
P11-24	The maximum running speed of the 3rd segment displacement	1~6000	rpm	200	Effective immediately	Running setting	P
P11-25	3rd segment displacement acceleration and deceleration time	0~65535	ms(s)	10	Effective immediately	Running setting	P
P11-26	Waiting time after the 3rd segment displacement is completed	0~10000	ms(s)	10	Effective immediately	Running setting	P
P11-27	4th segment movement displacement	-1073741824 ~1073741824	Command unit	10000	Effective immediately	Running setting	P
P11-29	The maximum running speed of the 4th segment displacement	1~6000	rpm	200	Effective immediately	Running setting	P
P11-30	4th segment displacement acceleration and deceleration time	0~65535	ms(s)	10	Effective immediately	Running setting	P
P11-31	Waiting time after the 4th segment displacement is completed	0~10000	ms(s)	10	Effective immediately	Running setting	P
P11-32	5th segment movement displacement	-1073741824 ~1073741824	Command unit	10000	Effective immediately	Running setting	P
P11-34	The maximum running speed of the 5th segment displacement	1~6000	rpm	200	Effective immediately	Running setting	P
P11-35	5th segment displacement acceleration and deceleration time	0~65535	ms(s)	10	Effective immediately	Running setting	P
P11-36	Waiting time after the 5th segment displacement is completed	0~10000	ms(s)	10	Effective immediately	Running setting	P

P11-37	6th segment movement displacement	-1073741824 ~1073741824	Command unit	10000	Effective immediately	Running setting	P
P11-39	The maximum running speed of the 6th segment displacement	1~6000	rpm	200	Effective immediately	Running setting	P
P11-40	6th segment displacement acceleration and deceleration time	0~65535	ms(s)	10	Effective immediately	Running setting	P
P11-41	Waiting time after the 6th segment displacement is completed	0~10000	ms(s)	10	Effective immediately	Running setting	P
P11-42	7th segment movement displacement	-1073741824 ~1073741824	Command unit	10000	Effective immediately	Running setting	P
P11-44	The maximum running speed of the 7th segment displacement	1~6000	rpm	200	Effective immediately	Running setting	P
P11-45	7th segment displacement acceleration and deceleration time	0~65535	ms(s)	10	Effective immediately	Running setting	P
P11-46	Waiting time after the 7th segment displacement is completed	0~10000	ms(s)	10	Effective immediately	Running setting	P
P11-47	8th segment movement displacement	-1073741824 ~1073741824	Command unit	10000	Effective immediately	Running setting	P
P11-49	The maximum running speed of the 8th segment displacement	1~6000	rpm	200	Effective immediately	Running setting	P
P11-50	8th segment displacement acceleration and deceleration time	0~65535	ms(s)	10	Effective immediately	Running setting	P
P11-51	Waiting time after the 8th segment displacement is completed	0~10000	ms(s)	10	Effective immediately	Running setting	P
P11-52	9th segment movement displacement	-1073741824 ~1073741824	Command unit	10000	Effective immediately	Running setting	P
P11-54	The maximum running speed of the 9th segment displacement	1~6000	rpm	200	Effective immediately	Running setting	P
P11-55	9th segment displacement acceleration and deceleration time	0~65535	ms(s)	10	Effective immediately	Running setting	P
P11-56	Waiting time after the 9th segment displacement is completed	0~10000	ms(s)	10	Effective immediately	Running setting	P
P11-57	10th segment movement displacement	-1073741824 ~1073741824	Command unit	10000	Effective immediately	Running setting	P
P11-59	The maximum running speed of the 10th segment displacement 16th segment of displacement	1~6000	rpm	200	Effective immediately	Running setting	P
P11-60	10th segment displacement acceleration and deceleration time	0~65535	ms(s)	10	Effective immediately	Running setting	P
P11-61	Waiting time after the 10th segment displacement is completed	0~10000	ms(s)	10	Effective immediately	Running setting	P
P11-62	11th segment movement displacement	-1073741824 ~1073741824	Command unit	10000	Effective immediately	Running setting	P
P11-64	The maximum running speed of the 11th segment displacement 16th segment of displacement	1~6000	rpm	200	Effective immediately	Running setting	P
P11-65	11th segment displacement acceleration and deceleration time	0~65535	ms(s)	10	Effective immediately	Running setting	P
P11-66	Waiting time after the 11th segment displacement is completed	0~10000	ms(s)	10	Effective immediately	Running setting	P
P11-67	12th segment movement displacement	-1073741824 ~1073741824	Command unit	10000	Effective immediately	Running setting	P
P11-69	The maximum running speed of the 12th segment displacement 16th segment of displacement	1~6000	rpm	200	Effective immediately	Running setting	P



P11-70	12th segment displacement acceleration and deceleration time	0~65535	ms(s)	10	Effective immediately	Running setting	P
P11-71	Waiting time after the 12th segment displacement is completed	0~10000	ms(s)	10	Effective immediately	Running setting	P
P11-72	13th segment movement displacement	-1073741824 ~1073741824	Command unit	10000	Effective immediately	Running setting	P
P11-74	The maximum running speed of the 13th segment displacement 16th segment of displacement	1~6000	rpm	200	Effective immediately	Running setting	P
Functional code	Name	Setting range	Unit	Factory setting	Effective method	Setting method	Related mode
P11-75	13th segment displacement acceleration and deceleration time	0~65535	ms(s)	10	Effective immediately	Running setting	P
P11-76	Waiting time after the 13th segment displacement is completed	0~10000	ms(s)	10	Effective immediately	Running setting	P
P11-77	14th segment movement displacement	-1073741824 ~1073741824	Command unit	10000	Effective immediately	Running setting	P
P11-79	The maximum running speed of the 14th segment displacement 16th segment of displacement	1~6000	rpm	200	Effective immediately	Running setting	P
P11-80	14th segment displacement acceleration and deceleration time	0~65535	ms(s)	10	Effective immediately	Running setting	P
P11-81	Waiting time after the 14th segment displacement is completed	0~10000	ms(s)	10	Effective immediately	Running setting	P
P11-82	15th segment movement displacement	-1073741824 ~1073741824	Command unit	10000	Effective immediately	Running setting	P
P11-84	The maximum running speed of the 15th segment displacement 16th segment of displacement	1~6000	rpm	200	Effective immediately	Running setting	P
P11-85	15th segment displacement acceleration and deceleration time	0~65535	ms(s)	10	Effective immediately	Running setting	P
P11-86	Waiting time after the 15th segment displacement is completed	0~10000	ms(s)	10	Effective immediately	Running setting	P
P11-87	16th segment movement displacement	-1073741824 ~1073741824	Command unit	10000	Effective immediately	Running setting	P
P11-89	Maximum running speed of 16th segment of displacement	1~6000	rpm	200	Effective immediately	Running setting	P
P11-90	16th segment displacement acceleration and deceleration time	0~65535	ms(s)	10	Effective immediately	Running setting	P
P11-91	Waiting time after the 16th segment displacement is completed	0~10000	ms(s)	10	Effective immediately	Running setting	P

## 7.15 P12 set multi-segment speed parameters

Functional code	Name	Setting range	Unit	Factory setting	Effective method	Setting method	Related mode
P12-00	Multi-segment speed command operation mode	0: Stop after a single operation; (P12-01 selects the number of segments) 1- Cycle operation (P12-01 selects the number of segments) 2- Switch via external DI	-	1	Effective immediately	Stop setting	S
P12-01	Speed command end segment selection	1~16	-	16	Effective immediately	Stop setting	S
P12-02	Running time unit selection	0-sec 1-min	-	0	Effective immediately	Stop setting	S
P12-03	Acceleration time 1	0~65535	ms	10	Effective immediately	Stop setting	S
P12-04	Deceleration time 1	0~65535	ms	10	Effective immediately	Stop setting	S

P12-05	Acceleration time 2	0-65535	ms	50	Effective immediately	Stop setting	S
P12-06	Deceleration time 2	0-65535	ms	50	Effective immediately	Stop setting	S
P12-07	Acceleration time 3	0-65535	ms	100	Effective immediately	Stop setting	S
P12-08	Deceleration time 3	0-65535	ms	100	Effective immediately	Stop setting	S
P12-09	Acceleration time 4	0-65535	ms	150	Effective immediately	Stop setting	S
P12-10	Deceleration time 4	0-65535	ms	150	Effective immediately	Stop setting	S
P12-20	1st segment speed command	-6000-6000	rpm	0	Effective immediately	Stop setting	S
P12-21	1st segment command running time	0-6553.5	s(min)	5.0	Effective immediately	Stop setting	S
P12-22	1st segment acceleration and deceleration time	0- Zero acc/dec time 1- Acc/Dec time 1 2- Acc/Dec time 2 3- Acc/Dec time 3 4- Acc/Dec time 4	-	0	Effective immediately	Stop setting	S
P12-23	2nd segment speed command	-6000-6000	rpm	100	Effective immediately	Stop setting	S
P12-24	2nd segment command running time	0-6553.5	s(min)	5.0	Effective immediately	Stop setting	S
P12-25	2nd segment acceleration and deceleration time	Refer to the description of P12-22	-	0	Effective immediately	Stop setting	S
P12-26	3rd segment speed command	-6000-6000	rpm	300	Effective immediately	Stop setting	S
P12-27	3rd segment command running time	0-6553.5	s(min)	5.0	Effective immediately	Stop setting	S
P12-28	3rd segment acceleration and deceleration time	Refer to the description of P12-22	-	0	Effective immediately	Stop setting	S
P12-29	4th segment speed command	-6000-6000	rpm	500	Effective immediately	Stop setting	S
P12-30	4th segment command running time	0-6553.5	s(min)	5.0	Effective immediately	Stop setting	S
P12-31	4th segment acceleration and deceleration time	Refer to the description of P12-22	-	0	Effective immediately	Stop setting	S
P12-32	5th segment speed command	-6000-6000	rpm	700	Effective immediately	Stop setting	S
P12-33	5th segment command running time	0-6553.5	s(min)	5.0	Effective immediately	Stop setting	S
P12-34	5th segment acceleration and deceleration time	Refer to the description of P12-22	-	0	Effective immediately	Stop setting	S
P12-35	6th segment speed command	-6000-6000	rpm	900	Effective immediately	Stop setting	S
P12-36	6th segment command running time	0-6553.5	s(min)	5.0	Effective immediately	Stop setting	S
P12-37	6th segment acceleration and deceleration time	Refer to the description of P12-22	-	0	Effective immediately	Stop setting	S
P12-38	7th segment speed command	-6000-6000	rpm	600	Effective immediately	Stop setting	S
P12-39	7th segment command running time	0-6553.5	s(min)	5.0	Effective immediately	Stop setting	S
P12-40	7th segment acceleration and deceleration time	Refer to the description of P12-22	-	0	Effective immediately	Stop setting	S
P12-41	8th segment speed command	-6000-6000	rpm	300	Effective immediately	Stop setting	S
P12-42	8th segment command running time	0-6553.5	s(min)	5.0	Effective immediately	Stop setting	S
P12-43	8th segment acceleration and deceleration time	Refer to the description of P12-22	-	0	Effective immediately	Stop setting	S
P12-44	9th segment speed command	-6000-6000	rpm	100	Effective immediately	Stop setting	S
P12-45	9th segment command running time	0-6553.5	s(min)	5.0	Effective immediately	Stop setting	S
P12-46	9th segment acceleration and deceleration time	Refer to the description of P12-22	-	0	Effective immediately	Stop setting	S
P12-47	10th segment speed command	-6000-6000	rpm	-100	Effective immediately	Stop setting	S
P12-48	10th segment command running time	0-6553.5	s(min)	5.0	Effective immediately	Stop setting	S
P12-49	10th segment acceleration and deceleration time	Refer to the description of P12-22	-	0	Effective immediately	Stop setting	S
P12-50	11th segment speed command	-6000-6000	rpm	-300	Effective immediately	Stop setting	S

P12-51	11th segment command running time	0~6553.5	s(min)	5.0	Effective immediately	Stop setting	S
P12-52	11th segment acceleration and deceleration time	Refer to the description of P12-22	-	0	Effective immediately	Stop setting	S
P12-53	12th segment speed command	-6000~6000	rpm	-500	Effective immediately	Stop setting	S
P12-54	12th segment command running time	0~6553.5	s(min)	5.0	Effective immediately	Stop setting	S
P12-55	12th segment acceleration and deceleration time	Refer to the description of P12-22	-	0	Effective immediately	Stop setting	S
P12-56	13th segment speed command	-6000~6000	rpm	-700	Effective immediately	Stop setting	S
P12-57	13th segment command running time	0~6553.5	s(min)	5.0	Effective immediately	Stop setting	S
P12-58	13th segment acceleration and deceleration time	Refer to the description of P12-22	-	0	Effective immediately	Stop setting	S
P12-59	14th segment speed command	-6000~6000	rpm	-900	Effective immediately	Stop setting	S
P12-60	14th segment command running time	0~6553.5	s(min)	5.0	Effective immediately	Stop setting	S
P12-61	14th segment acceleration and deceleration time	Refer to the description of P12-22	-	0	Effective immediately	Stop setting	S
P12-62	15th segment speed command	-6000~6000	rpm	-600	Effective immediately	Stop setting	S
P12-63	15th segment command running time	0~6553.5	s(min)	5.0	Effective immediately	Stop setting	S
P12-64	15th segment acceleration and deceleration time	Refer to the description of P12-22	-	0	Effective immediately	Stop setting	S
P12-65	16th segment speed command	-6000~6000	rpm	-300	Effective immediately	Stop setting	S
P12-66	16th segment command running time	0~6553.5	s(min)	5.0	Effective immediately	Stop setting	S
P12-67	16th segment acceleration and deceleration time	Refer to the description of P12-22	-	0	Effective immediately	Stop setting	S

## 7.16 P17 set virtual DIDO parameters

Functional code	Name	Setting range	Unit	Factory setting	Effective method	Setting method	Related mode
P17-00	VDI1 terminal function selection	0~37	-	0	Effective at stop	Running setting	-
P17-01	VDI1 terminal logic selection	0- Means active when VDI1 write 1 1- Means active when write value of VDI1 changes from 0 to 1	-	0	Effective at stop	Running setting	-
P17-02	VDI2 terminal function selection	0~37	-	0	Effective at stop	Running setting	-
P17-03	VDI2 terminal logic selection	0- Means active when VDI2 write 1 1- Means active when write value of VDI2 changes from 0 to 1	-	0	Effective at stop	Running setting	-
P17-04	VDI3 terminal function selection	0~37	-	0	Effective at stop	Running setting	-
P17-05	VDI3 terminal logic selection	0- Means active when VDI3 write 1 1- Means active when write value of VDI3 changes from 0 to 1	-	0	Effective at stop	Running setting	-
P17-06	VDI4 terminal function selection	0~37	-	0	Effective at stop	Running setting	-
P17-07	VDI4 terminal logic selection	0- Means active when VDI4 write 1 1- Means active when write value of VDI4 changes from 0 to 1	-	0	Effective at stop	Running setting	-
P17-08	VDI5 terminal function selection	0~37	-	0	Effective at stop	Running setting	-
P17-09	VDI5 terminal logic selection	0- Means active when VDI5 write 1 1- Means active when write value of VDI5 changes from 0 to 1	-	0	Effective at stop	Running setting	-
P17-10	VDI6 terminal function selection	0~37	-	0	Effective at stop	Running setting	-
P17-11	VDI6 terminal logic selection	0- Means active when VDI6 write 1 1- Means active when write value of VDI6 changes from 0 to 1	-	0	Effective at stop	Running setting	-
P17-12	VDI7 terminal function selection	0~37	-	0	Effective at stop	Running setting	-

P17-13	VDI7 terminal logic selection	0- Means active when VDI7 write 1 1- Means active when write value of VDI7 changes from 0 to 1	-	0	Effective at stop	Running setting	-
P17-14	VDI8 terminal function selection	0-37	-	0	Effective at stop	Running setting	-
P17-15	VDI8 terminal logic selection	0- Means active when VDI8 write 1 1- Means active when write value of VDI8 changes from 0 to 1	-	0	Effective at stop	Running setting	-
P17-16	VDI9 terminal function selection	0-37	-	0	Effective at stop	Running setting	-
P17-17	VDI9 terminal logic selection	0- Means active when VDI9 write 1 1- Means active when write value of VDI9 changes from 0 to 1	-	0	Effective at stop	Running setting	-
P17-18	VDI10 terminal function selection	0-37	-	0	Effective at stop	Running setting	-
P17-19	VDI10 terminal logic selection	0- Means active when VDI10 write 1 1- Means active when write value of VDI10 changes from 0 to 1	-	0	Effective at stop	Running setting	-
P17-20	VDI11 terminal function selection	0-37	-	0	Effective at stop	Running setting	-
P17-21	VDI11 terminal logic selection	0- Means active when VDI11 write 1 1- Means active when write value of VDI11 changes from 0 to 1	-	0	Effective at stop	Running setting	-
P17-22	VDI12 terminal function selection	0-37	-	0	Effective at stop	Running setting	-
P17-23	VDI12 terminal logic selection	0- Means active when VDI12 write 1 1- Means active when write value of VDI12 changes from 0 to 1	-	0	Effective at stop	Running setting	-
P17-24	VDI13 terminal function selection	0-37	-	0	Effective at stop	Running setting	-
P17-25	VDI13 terminal logic selection	0- Means active when VDI13 write 1 1- Means active when write value of VDI13 changes from 0 to 1	-	0	Effective at stop	Running setting	-
P17-26	VDI14 terminal function selection	0-37	-	0	Effective at stop	Running setting	-
P17-27	VDI14 terminal logic selection	0- Means active when VDI14 write 1 1- Means active when write value of VDI14 changes from 0 to 1	-	0	Effective at stop	Running setting	-
P17-28	VDI15 terminal function selection	0-37	-	0	Effective at stop	Running setting	-
P17-29	VDI15 terminal logic selection	0- Means active when VDI15 write 1 1- Means active when write value of VDI15 changes from 0 to 1	-	0	Effective at stop	Running setting	-
P17-30	VDI16 terminal function selection	0-37	-	0	Effective at stop	Running setting	-
P17-31	VDI16 terminal logic selection	0- Means active when VDI16 write 1 1- Means active when write value of VDI16 changes from 0 to 1	-	0	Effective at stop	Running setting	-
P17-32	VDO virtual level	-	-	-	-	Display	-
P17-33	VDO1 terminal function selection	0-22	-	0	Effective at stop	Running setting	-
P17-34	VDO1 terminal logic selection	0- Means output 1 when active 1- Means output 0 when active	-	0	Effective at stop	Running setting	-
P17-35	VDO2 terminal function selection	0-22	-	0	Effective at stop	Running setting	-
P17-36	VDO2 terminal logic selection	0- Means output 1 when active 1- Means output 0 when active	-	0	Effective at stop	Running setting	-
P17-37	VDO3 terminal function selection	0-22	-	0	Effective at stop	Running setting	-
P17-38	VDO3 terminal logic selection	0- Means output 1 when active 1- Means output 0 when active	-	0	Effective at stop	Running setting	-
P17-39	VDO4 terminal function selection	0-22	-	0	Effective at stop	Running setting	-
P17-40	VDO4 terminal logic selection	0- Means output 1 when active 1- Means output 0 when active	-	0	Effective at stop	Running setting	-
P17-41	VDO5 terminal function selection	0-22	-	0	Effective at stop	Running setting	-
P17-42	VDO5 terminal logic selection	0- Means output 1 when active 1- Means output 0 when active	-	0	Effective at stop	Running setting	-

P17-43	VDO6 terminal function selection	0-22	-	0	Effective at stop	Running setting	-
P17-44	VDO6 terminal logic selection	0- Means output 1 when active 1- Means output 0 when active	-	0	Effective at stop	Running setting	-
P17-45	VDO7 terminal function selection	0-22	-	0	Effective at stop	Running setting	-
P17-46	VDO7 terminal logic selection	0- Means output 1 when active 1- Means output 0 when active	-	0	Effective at stop	Running setting	-
P17-47	VDO8 terminal function selection	0-22	-	0	Effective at stop	Running setting	-
P17-48	VDO8 terminal logic selection	0- Means output 1 when active 1- Means output 0 when active	-	0	Effective at stop	Running setting	-
P17-49	VDO9 terminal function selection	0-22	-	0	Effective at stop	Running setting	-
P17-50	VDO9 terminal logic selection	0- Means output 1 when active 1- Means output 0 when active	-	0	Effective at stop	Running setting	-
P17-51	VDO10 terminal function selection	0-22	-	0	Effective at stop	Running setting	-
P17-52	VDO10 terminal logic selection	0- Means output 1 when active 1- Means output 0 when active	-	0	Effective at stop	Running setting	-
P17-53	VDO11 terminal function selection	0-22	-	0	Effective at stop	Running setting	-
P17-54	VDO11 terminal logic selection	0- Means output 1 when active 1- Means output 0 when active	-	0	Effective at stop	Running setting	-
P17-55	VDO12 terminal function selection	0-22	-	0	Effective at stop	Running setting	-
P17-56	VDO12 terminal logic selection	0- Means output 1 when active 1- Means output 0 when active	-	0	Effective at stop	Running setting	-
P17-57	VDO13 terminal function selection	0-22	-	0	Effective at stop	Running setting	-
P17-58	VDO13 terminal logic selection	0- Means output 1 when active 1- Means output 0 when active	-	0	Effective at stop	Running setting	-
P17-59	VDO14 terminal function selection	0-22	-	0	Effective at stop	Running setting	-
P17-60	VDO14 terminal logic selection	0- Means output 1 when active 1- Means output 0 when active	-	0	Effective at stop	Running setting	-
P17-61	VDO15 terminal function selection	0-22	-	0	Effective at stop	Running setting	-
P17-62	VDO15 terminal logic selection	0- Means output 1 when active 1- Means output 0 when active	-	0	Effective at stop	Running setting	-
P17-63	VDO16 terminal function selection	0-22	-	0	Effective at stop	Running setting	-
P17-64	VDO16 terminal logic selection	0- Means output 1 when active 1- Means output 0 when active	-	0	Effective at stop	Running setting	-

## 7.17 P30 set communication reading servo related variables

Functional code	Name	Setting range	Unit	Factory setting	Effective method	Setting method	Related mode
P30-00	Communication reading servo status	-	-	-	-	Communication read only	PST
P30-01	Communication reading DO function status 1	-	-	-	-	Communication read only	PST
P30-02	Communication reading DO function status 2	-	-	-	-	Communication read only	PST
P30-03	Communication reading input pulse command sampling value	-	-	-	-	Display	PST
P30-04	Communication reading DI conduction status	0-511	-	-	-	Display	PST

## 7.18 P31 set communication given servo related variables

Functional code	Name	Setting range	Unit	Factory setting	Effective method	Setting method	Related mode
P31-00	Communication given VDI virtual level	0-65535	-	0	Effective immediately	Running setting	PST
P31-04	Communication given DO output status	0-31	-	0	Effective immediately	Running setting	PST

## Chapter VIII Troubleshooting

### 8.1 Fault and Warning Code List

#### 8.1.1 Fault code table (to reset the fault, you need to cancel the enable first)

Display	Fault name	Can it be Reset	Fault and handling method
Er.101	Parameters of P02 and above sets are abnormal	No	<ol style="list-style-type: none"> <li>1. The function code parameter value of P02 and following sets exceeds the upper and lower limits, and the parameters are re-initialized;</li> <li>2. Power off during the process of writing parameters, rewrite the parameters after power on;</li> <li>3. Reset the motor model and drive model, and initialize the parameters;</li> <li>4. The drive EEPROM is abnormal, replace the drive.</li> </ol>
Er.102	Programmable logic configuration failure	No	MCU related hardware is damaged, replace the drive.
Er.104	Programmable logic interrupt failure	No	MCU related hardware is damaged, replace the drive.
Er.105	Abnormal internal program	No	<ol style="list-style-type: none"> <li>1. When EEPROM reads/writes function codes, the total number of function codes is abnormal, initialize the parameters;</li> <li>2. The range of the set value of the function code is abnormal, initialize the parameters;</li> <li>3. Initialize and power on again. If the alarm still occurs, replace the drive.</li> </ol>
Er.108	Parameter storage failure	No	<ol style="list-style-type: none"> <li>1. The parameter value can't be written to the EEPROM, initialize the parameter;</li> <li>2. Initialize and power on again. If the alarm still occurs, replace the drive.</li> </ol>
Er.111	Internal failure	No	Initialize and power on again. If the alarm still occurs, replace the drive.
Er.120	Product matching failure	No	The motor model and drive model match incorrectly, please contact the after-sales personnel to check the motor model.
Er.121	Servo ON command invalid fault	Yes	DI port parameter configuration fault, recheck DI function and VDI function configuration
Er.122	Absolute position mode product matching failure	No	The absolute value motor model does not match, or the motor model is set incorrectly, please contact the after-sales personnel to check the motor model.
Er.130	Duplicate assignment of DI function	Yes	DI port parameter configuration failure, recheck the DI function and VDI function configuration or initialize parameters.
Er.131	DO function allocation overrun	Yes	DO function number exceeds DO function number, recheck DO function configuration or initialize parameters.
Er.136	The data in motor ROM is incorrectly verified or the parameters are not saved	No	<p>When the drive reads the parameters in the encoder ROM area, it finds that the parameters are not saved, or the parameters are inconsistent with the agreed values</p> <ol style="list-style-type: none"> <li>1. Check the motor model and drive model;</li> <li>2. Check whether the motor encoder cable is correct, and whether the connector is connected reliably;</li> <li>3. Check if the encoder line is disturbed, and re-arrange the wires.</li> </ol>
Er.201	Overcurrent 2	No	<p>Overcurrent detected by hardware;</p> <ol style="list-style-type: none"> <li>1. Check whether the motor power lines U V W are correctly connected, and whether there is a reverse connection or phase loss;</li> <li>2. There is a short circuit in the U V W lines, or there is leakage between the motor coil and the casing, replace the motor wire or test the motor;</li> <li>3. The encoder line is in poor contact, check or replace the encoder cable;</li> <li>4. The load is too heavy, first test whether the motor is normal with no load;</li> <li>5. The acceleration and deceleration are too fast, increase the acceleration and deceleration time of the program;</li> <li>6. If the gain parameter is adjusted, check whether the gain is set too large, and test after reducing the gain;</li> <li>7. The braking resistor is too small or short-circuited, test with internal braking resistor first;</li> <li>8. The drive is damaged, replace the drive;</li> </ol>
Er.207	D/Q axis current overflow fault	Yes	Abnormal current feedback causes the internal register of the drive to overflow, replace the drive;

Er.208	System sampling operation timeout	No	<ol style="list-style-type: none"> <li>1. MCU communication timeout, replace the drive</li> <li>2. Encoder communication times out, check whether the encoder line is connected well, or replace the encoder and reconnect;</li> <li>3. Motor encoder is faulty, replace the motor for test;</li> <li>4. Current sampling times out, check whether there is interference from large equipment on site, increase the isolation transformer, and re-arrange the wires;</li> <li>5. High-precision AD conversion times out, check the analog input wiring to see if there is interference, and connect with shielded wire;</li> <li>6. The drive is damaged, replace the drive;</li> </ol>
Er.210	Output short circuit to ground	No	<p>During the power-on self-test of the drive, the motor phase current or bus voltage is detected abnormal.</p> <ol style="list-style-type: none"> <li>1. The power lines U V W are short-circuited to the ground, check the motor lines;</li> <li>2. The motor coil is short-circuited to the casing, replace the motor;</li> <li>3. Drive failure, replace the drive.</li> </ol>
Er.220	Phase sequence error	No	<p>The drive performs angle identification, and it is identified that the phase sequence of the UVW of the drive and the UVW of the motor do not match.</p> <ol style="list-style-type: none"> <li>1. The electrical angle of the motor encoder does not match, reset the motor parameters, and self-learn;</li> <li>2. The U V W phase sequence is reversed, check the motor power lines;</li> </ol>
Er.234	Overspeed	No	<p>In torque control mode, the direction of the torque command is opposite to the direction of the speed feedback or in the position or speed control mode, the direction of the speed feedback is opposite to the direction of the speed command;</p> <ol style="list-style-type: none"> <li>1. The U V W phase sequence is reversed, check the motor power lines;</li> <li>2. Initial phase detection error of the motor rotor is caused by the interference signal, re-power on, and check the wiring;</li> <li>3. The encoder model is wrong or the wiring is wrong, replace the motor or encoder line;</li> <li>4. Drive failure, replace the drive;</li> </ol>
Er.400	Main circuit overvoltage	Yes	<p>DC bus voltage exceeds fault value 420V</p> <ol style="list-style-type: none"> <li>1. Measure the power supply voltage. If the grid voltage is too high or unstable, a voltage stabilizer needs to be added;</li> <li>2. The braking resistor fails, measure the resistance between B1 and B3 of the drive in the state of complete power failure. If it is infinite, the internal braking resistor is damaged and the drive needs to be replaced;</li> <li>3. The resistance of the braking resistor is too large, replace it with a braking resistor of 40 ohms or 50 ohms, please contact the after-sales personnel;</li> <li>4. The grid voltage is too high, and the motor accelerates and decelerates too fast, increase the acceleration and deceleration time;</li> <li>5. Monitor P0B-26 to check whether the bus voltage is consistent with the grid voltage. If the difference is too large, the drive may be damaged and needs to be replaced. 220V AC corresponds to the bus voltage of 310V.</li> </ol>
Er.410	Main circuit undervoltage	Yes	<p>DC bus voltage is lower than the fault value 200V</p> <ol style="list-style-type: none"> <li>1. The main circuit power supply is unstable or power off, re-check the wiring, or add a voltage stabilizer;</li> <li>2. Monitor P0B-26 to check whether the bus voltage is consistent with the grid voltage. If the difference is too large, the drive may be damaged and needs to be replaced. 220V AC corresponds to the bus voltage of 310V.</li> </ol>
Er.420	Main circuit power phase loss	Yes	Servo drive failure, replace the drive.
Er.430	Control power undervoltage	Yes	Servo drive failure, replace the drive.
Er.500	Overspeed alarm	Yes	<p>The actual speed of the servo motor exceeds the overspeed fault threshold</p> <ol style="list-style-type: none"> <li>1. The phase sequence of motor cable U V W is wrong, check the motor wiring;</li> <li>2. The motor parameters are incorrect, reset the motor parameters and self-learn;</li> <li>3. The input command exceeds the overspeed fault threshold;</li> <li>4. The motor speed is overregulated, the gain parameter setting is unreasonable, initialize the drive parameters and test;</li> <li>5. Drive failure, replace the drive.</li> </ol>
Er.510	Pulse output overspeed	Yes	The output pulse frequency exceeds the upper limit of the frequency allowed by the hardware: reduce P05-17 (number of pulses divided by the encoder frequency), so that the output pulse frequency is less than the upper limit of the allowable frequency.
Er.602	Angle identification failed	Yes	Motor self-learning failed, check whether the encoder line is normal and the encoder type is correct.

Er.610	Drive overload	Yes	1. The motor model or drive model is set incorrectly, please contact the after-sales personnel to check the parameters; 2. Monitor the drive load rate PB-02 to see if the overload causes an alarm; 3. The motor is stalled, first eliminate the motor stall and then test, or remove the motor for no-load test;
Er.620	Motor overload	Yes	4. The gain parameter setting is too large, test after initializing the parameters; 5. Motor acceleration and deceleration is too fast, increase the acceleration and deceleration time; 6. The phase sequence of motor cable U V W is wrong, check the motor wiring; 7. The drive is damaged, replace the drive.
Er.625	Brake closed abnormally	Yes	After the brake protection is turned on, the brake output signal is valid, the first 100~500ms of the input command is zero, the output torque is less than 70% of the gravity load detection value. Confirm whether the signal of the motor brake terminal is valid and whether the motor brake relay is damaged
Er.626	Brake opened abnormally	Yes	After the brake protection is turned on, the output signal of the brake is invalid, but it is detected that the motor rotates more than two turns Check whether the motor brake terminal signal is valid and whether the motor brake relay is damaged.
Er.630	Motor stall	Yes	The actual speed of the motor is lower than 10rpm, but the torque command reaches the limit value, and the duration reaches the set value of P0A-32 1. The UVW output of the drive is out of phase, disconnected, and wrongly connected in phase sequence; 2. The motor parameters are incorrect, reset the motor parameters and self-learn; 3. The motor is stalled, first eliminate the motor stall and then test, or remove the motor for no-load test;
Er.650	Heat sink overheating	Yes	The temperature of the power module of the drive is higher than the over-temperature protection point, the servo drive is faulty, replace the drive.
Er.731	Encoder battery failure	Yes	The battery voltage of the absolute value encoder is lower than 3.0V 1. The encoder line is disconnected, set P0D-20=2, and then set P0D-01=1 to clear the fault; 2. The battery is dead, replace the battery.
Er.733	Encoder multi-turn count error	Yes	Initialize the drive parameters, reset the motor parameters and drive parameters, set the encoder type, Then set P0D-20=2 and P0D-01=1 to clear the fault and power on again. If the alarm still occurs, replace the motor and test.
Er.735	Encoder multi-turn count overflow	Yes	Initialize the drive parameters, reset the motor parameters and drive parameters, set the encoder type, Then set P0D-20=2 and P0D-01=1 to clear the fault and power on again. If the alarm still occurs, replace the motor and test.
Er.740	Encoder interference	No	Encoder Z signal is interfered, causing the electrical angle corresponding to the Z signal to change too much 1. The encoder wiring is wrong or the connector is loose, check or replace the encoder line and test it; 2. Encoder Z signal is disturbed, re-wire and ensure a good grounding; 3. The encoder is faulty, replace the motor;
Er.834	AD sampling overvoltage	Yes	AI sampling value is greater than 11.5V 1. Check whether the input analog voltage value is too high; 2. Analog input port of the drive is faulty, replace the drive.
Er.835	AD sampling failure	Yes	AD circuit is disturbed There is interference in the AI channel wiring, check the analog signal wiring, and use shielded twisted pair.
Er.A33	Encoder data abnormal	No	The internal parameters of the encoder are abnormal 1. The serial encoder line is disconnected or loose, check or replace the encoder line and test; 2. The encoder is faulty, replace the motor;
Er.A34	Encoder loopback verification abnormal	No	1. The driver and motor types do not match, reset the motor model; 2. The encoder line is broken, check the encoder line.
Er.A35	Z signal loss	No	Encoder Z signal is lost or the AB signal edge transitions at the same time 1. The serial encoder line is disconnected or loose, check or replace the encoder line and test; 2. The encoder is faulty, replace the motor;



Er.B00	Excessive position deviation	Yes	In position control mode, the position deviation is greater than the set value of P0A-10 1. The drive U V W output has phase loss or the phase sequence is wrongly connected, check the motor wire; 2. The motor is stalled, first eliminate the motor stall and then test, or remove the motor for no-load test; 3. The gain of servo drive is low, initialize the parameters and test; 4. The input pulse frequency is high, reduce the input pulse frequency; 5. Compared with the operating conditions, the fault value (P0A-10) is too small, increase P0A-10; 6. The torque limit value P07-09~P07-12 is set too small, initialize the parameters and test; 7. Servo drive/motor failure, replace the drive or motor.
Er.B01	Abnormal pulse input	Yes	The input pulse frequency is greater than the maximum position pulse frequency (P0A-09) 1. Reduce the input pulse frequency; 2. Caused by input pulse interference, the pulse line should use twisted pair shielded wire and be properly grounded; 3. The pulse signal switching power supply is infected. Use the internal 24V power supply of the drive as the pulse signal power supply.
Er.B03	Electronic gear ratio setting exceeds the limit	Yes	A group of electronic gear ratio exceeds the limit value, check the electronic gear ratio setting value.

### 8.1.2 Warning code table (warnings can be reset directly, no need to disable)

Display	Warning name	Can it be Reset	Warning and handling method
Er.110	Frequency division pulse output setting failure	Yes	When using the encoder frequency division output function (P05-38=0), the set encoder frequency division pulse number does not meet the threshold determined by the encoder specification, reset the encoder frequency division pulse number (P05-17) to make it meet the specified range.
Er.601	Homing failed	Yes	When using the homing function (P05-30=1~5), the home is not found within the time set by P05-35. 1. Increase the time of P05-34; 2. Check whether the home signal is valid, change the home set point, or change the home search direction;
Er.730	Encoder battery warning	Yes	The battery voltage of the absolute value encoder is lower than 3.0V. Replace the battery with a new one that matches the voltage in the power-on state.
Er.831	AI zero drift is too large	Yes	When the input voltage of AI (including AI1 and AI2) terminals is 0V, the voltage sampled by the driver is greater than 500mV, Check AI input wiring, use shielded twisted pair.
Er.900	DI emergency stop	Yes	DI terminal corresponding to DI function 34 (FunIN.34: brake, Emergency) is triggered (including hardware DI and virtual DI), check the DI wiring.
Er.909	Motor overload warning	Yes	The load rate is too high and causes a warning; check whether the load is too heavy or there is a stall condition.
Er.920	Braking resistor overload	Yes	Braking resistor current excessive warning 1. Check if the bus voltage is too high and the energy discharges too quickly; add a voltage regulator and reduce the voltage; 2. Check if the motor decelerates too fast, increase the deceleration time; 3. The power of the internal braking resistor is insufficient. Replace the external braking resistor. It is recommended that the resistance value should not be lower than 35 ohms. 4. When using an external resistor, check the parameter values of P02-25 ~ P2-27, and set the value of P2-27 to be consistent with the resistance value of the selected resistor; 4. The brake circuit of the drive is damaged, replace the drive;
Er.922	External braking resistor is too small	Yes	P02-27 (resistance value of external braking resistor) is less than P02-21 (minimum value of external braking resistor allowed by the drive)
Er.939	Motor power line is disconnected	Yes	The actual phase current of the motor is less than 10% of the rated current, and the actual speed is small, but the internal torque command is large, check the wiring of the motor power cable, rewire, and replace the cable if necessary
Er.941	Changed parameters take effect after powering on again	Yes	When the function code attribute "Effective time" of the servo drive is "power on again", the drive reminds the user that it needs to be powered on again after the parameter value of the function code is changed
Er.942	Frequent parameter storage	Yes	If the number of function codes modified at the same time exceeds 200, check the operation mode. For parameters that do not need to be stored in EEPROM, set P0C-13 to 0 before the host computer writes
Er.950	Forward overtravel warning	Yes	The corresponding DI terminal of DI function 14 (FunIN.14: P-OT, forward overtravel switch) is triggered.
Er.952	Reverse overtravel warning	Yes	The corresponding DI terminal of DI function 15 (FunIN.15: N-OT, reverse overtravel switch) is triggered.

Er.980	Encoder internal fault	Yes	The encoder algorithm is faulty; if the fault is still reported after turning on the power for many times, replace the motor.
Er.A40	Internal failure	Yes	Motor self-learning failed 1. Check the motor encoder line error; 2. The encoder model is wrong, reset the motor model and encoder type; 3. The motor encoder is faulty, replace the motor.

## Chapter IX MODBUS Communication

This series of drives has two RS485 interfaces, which can communicate with the computer through USB-to-485 communication line for parameter setting, or control the drive to run the internal multi-segment position or multi-speed mode through the RS485 master station controller.

### 9.1 Wiring and Setup

#### 9.1.1 Topology structure

CN3 and CN4 of the drive are RS485 interfaces. For specific pin definitions, please refer to chapter 4.3.1. When multiple nodes are used for communication control, a bus topology should be used, and the last one needs to be connected to a 120-ohm terminal resistor.

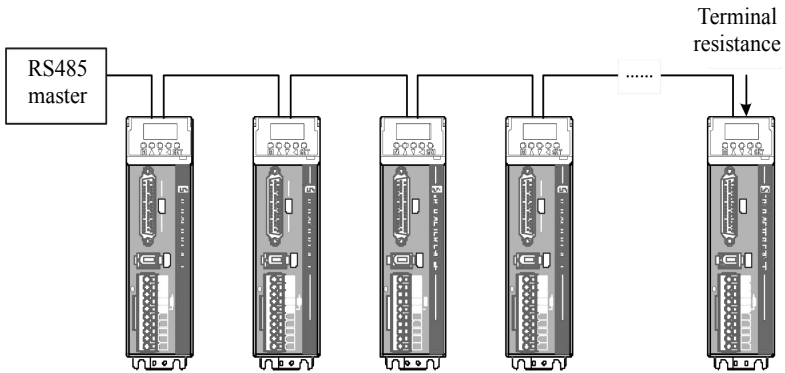

#### 9.1.2 Related parameters

No.	Parameter name	Setting range	Factory setting
P0C-00	Servo axis address	1~247, 0 is the broadcast address	1
P0C-02	Serial port baud rate setting	0-2400bps 1-4800bps 2-9600bps 3-19200bps 4-38400bps 5-57600bps	5
P0C-03	Moubus data format	0: No parity, 2 stop bits 1: Even parity, 1 stop bit; 2: Odd parity, 1 stop bit; 3: No parity, 1 stop bit	0

P0C-13	Whether the write function code of Moubus communication is updated to EEPROM	0: Do not update EEPROM 1: Update except P0B set and P0D set EEPROM	1
--------	--	--	---

**Note: To write parameters frequently, you need to set P0C-13 to 0 to prevent damage to the drive!**

### 9.1.3 Communication address description

The communication address of the parameter can be calculated from the parameter number in the following method:

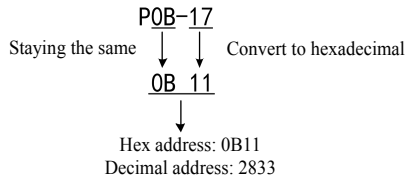

## 9.2 MODBUS communication protocol

### 9.2.1 Read register command (0x06)

Command sent by master station (PLC, etc.):

Byte order	Command example	Functional symbols	Functions
1st Byte	0x01	Slave Addr	Slave address, here is 1
2nd Byte	0x03	CMD	Function code, here is 0x03, indicating that it is a command to read parameters
3rd Byte	0x0B	Start AddrH	Upper 8 bits of the starting address of the read parameter
4th Byte	0x11	Start AddrL	Lower 8 bits of the starting address of the read parameter
5th Byte	0x00	Num_High (Byte)	Upper 8 bits of the number of read parameters Note: The number here refers to how many registers (words), not how many bytes.
6th Byte	0x02	Num_Low (Byte)	Lower 8 bits of the number of read parameters
7th Byte	0x96	CRC_H	High bit of CRC check. CRC check refers to the CRC checksum of the 1st to the previous byte (here is the 6th byte).
8th Byte	0x2A	CRC_L	Low bit of CRC check.

[For the above example: Two parameters are read from the master station with the slave station address set as 1 and the starting address, as 2833(0x0B11), namely, two bytes are read]

Slave station (servo drive) response:

Byte order	Command example	Functional symbols	Functions
1st Byte	0x01	Slave Addr	Slave address, here is 1
2nd Byte	0x03	CMD	Function code, 0x03, corresponding to the master command
3rd Byte	0x04	Data LenH	Data length of the response, unit: bytes
4th Byte	0x00	Data(0)	Data 0 (high bit of the 1st register)
5th Byte	0x64	Data(0)	Data 0 (low bit of the 1st register)
6th Byte	0x00	Data(1)	Data 1 (high bit of the 2nd register)
7th Byte	0xC8	Data(1)	Data 1 (low bit of the 2nd register)
8th Byte	0xBA	CRC_H	High bit of CRC check. CRC check refers to the CRC checksum of the 1st to the previous byte (here is the 9th byte).
9th Byte	0x7A	CRC_L	Low bit of CRC check.

[Response data0:0x0064; data1:0x00C8], converted to 32-bit data 00C80064, which is decimal 13107300.

### 9.2.2 Write single-register command (0x06)

Command sent by master station (PLC, etc.):

Byte order	Command example	Functional symbols	Functions
1st Byte	0x01	Slave Addr	Slave address, here is 1
2nd Byte	0x06	CMD	Function code, here is 0x06, indicating that it is to write a parameter command
3rd Byte	0x12	Start AddrH	Upper 8 bits of the starting address of the written parameter
4th Byte	0x14	Start AddrL	Lower 8 bits of the starting address of the written parameter
5th Byte	0x01	DATA(0)	Upper 8 bits of the written data.
6th Byte	0xF4	DATA(1)	Lower 8 bits of the written data.
7th Byte	0xCC	CRC_H	High bit of CRC check. CRC check refers to the CRC checksum of the 1st to the previous byte (here is the 6th byte).
8th Byte	0xA1	CRC_L	Low bit of CRC check.

[For the above example: A parameter is written from the master station with the slave station address set as 1 and the starting address, as 4628(0x1214), the value is 500(0x01F4)]

Slave station (servo drive) response:

Byte order	Command example	Functional symbols	Functions
1st Byte	0x01	Slave Addr	Slave address, here is 1
2nd Byte	0x06	CMD	Function code, 0x06, corresponding to the master command
3rd Byte	0x12	Start AddrH	Upper 8 bits of the starting address of the written parameter
4th Byte	0x14	Start AddrL	Lower 8 bits of the starting address of the written parameter
5th Byte	0x01	DATA(0)	Upper 8 bits of the written data.
6th Byte	0xF4	DATA(1)	Lower 8 bits of the written data.

7th Byte	0xCC	CRC_H	High bit of CRC check. CRC check refers to the CRC checksum of the 1st to the previous byte (here is the 6th byte).
8th Byte	0xA1	CRC_L	Low bit of CRC check.

[The response is the same as the command sent by the master]

### 9.2.3 Write multi-register command (0x10)

Command sent by the station (PLC, etc.):

Byte order	Command example	Functional symbols	Functions
1st Byte	0x01	Slave Addr	Slave address, here is 1
2nd Byte	0x10	CMD	Function code, here is 0x10, indicating that it is to write multiple parameter commands
3rd Byte	0x11	Start AddrH	Upper 8 bits of the starting address of the written parameter
4th Byte	0x0C	Start AddrL	Lower 8 bits of the starting address of the written parameter
5th Byte	0x00	NUM_H	Upper 8 bits of the number of parameters (registers) written
6th Byte	0x02	NUM_L	Lower 8 bits of the number of parameters (registers) written
7th Byte	0x04	Data Length	The number of bytes of the parameter written is twice the number of registers
8th Byte	0x38	DATA(0)	Upper 8 bits of the first data written.
9th Byte	0x80	DATA(0)	Lower 8 bits of the first data written.
10th Byte	0x00	DATA(1)	Upper 8 bits of the second data written.
11th Byte	0x01	DATA(1)	Lower 8 bits of the second data written.
12th Byte	0xFE	CRC_H	High bit of CRC check. CRC check refers to the CRC checksum of the 1st to the previous byte (here is the 6th byte).
13th Byte	0xE2	CRC_L	Low bit of CRC check.

[For the above example: the master station writes 32-bit data 80000 (0x13880) to the place where the slave station address is 1 and the starting address is 4364 (0x110C)]

Slave station (servo drive) response:

Byte order	Command example	Functional symbols	Functions
1st Byte	0x01	Slave Addr	Slave address, here is 1
2nd Byte	0x10	CMD	Function code, 0x10, corresponding to the master command
3rd Byte	0x11	Start AddrH	Upper 8 bits of the starting address of the written parameter
4th Byte	0x0C	Start AddrL	Lower 8 bits of the starting address of the written parameter
5th Byte	0x00	NUM_H	Upper 8 bits of the number of parameters to be written (number of registers).
6th Byte	0x04	NUM_L	Lower 8 bits of the number of parameters to be written (number of registers).
7th Byte	0x04	CRC_H	High bit of CRC check. CRC check refers to the CRC checksum of the 1st to the previous byte (here is the 6th byte).

8th Byte	0xF5	CRC_L	Low bit of CRC check.
----------	------	-------	-----------------------

### 9.2.4 Response exception and error codes

Regardless of the read or write command, if the slave responds abnormally, its response frame is changed. As follows

Byte order	Command example	Functional symbols	Functions
1st Byte	0x01	Slave Addr	Slave address, here is 1
2nd Byte	0x83	CMD)0x80	0x80 + function code
3rd Byte	0x02	Error Code	Error code. There are the following types: 0x01- Illegal command code 0x02: Illegal address 0x03: Illegal data 0x04: Refused to execute
4th Byte	0xC0	CRC_H	High bit of CRC check. CRC check refers to the CRC checksum of the 1st to the previous byte (here is the 3rd byte).
5th Byte	0x F1	CRC_L	Low bit of CRC check.

### 9.2.5 CRC check

When the host computer communicates with the servo drive, a consistent CRC check algorithm must be used, or CRC check error will occur. The servo drive adopts 16-bit CRC, with the low byte in front and the high byte in the back; the CRC function is as follows:

Uin16 COMM\_CrcValueCalc(const Uint8 \*data, Uint16 length)

```

{
    Uint16 crcValue = 0xffff; int16 i;
    while (length--)
    {
        crcValue ^= *data++; for (i = 0; i < 8; i++)
        {
            if (crcValue & 0x0001)
            {
                crcValue = (crcValue >> 1) ^ 0xA001;
            }
            else
            {
                crcValue = crcValue >> 1;
            }
        }
    }
    return (crcValue);
}

```



